

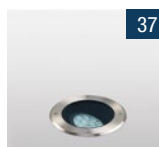









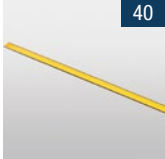





































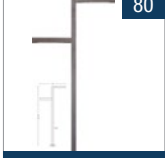

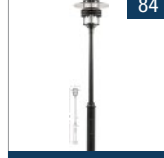

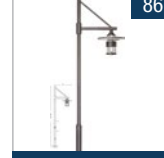





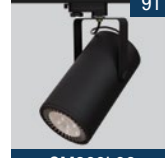
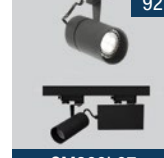





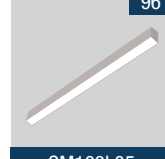
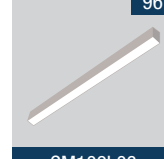
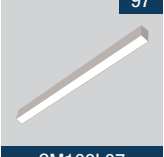
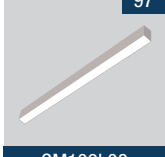
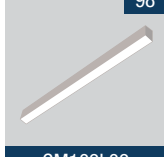













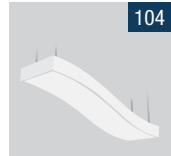
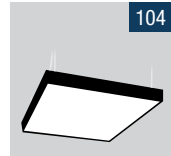
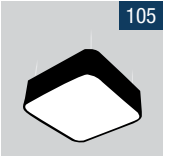

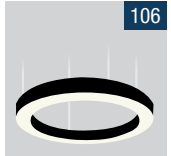
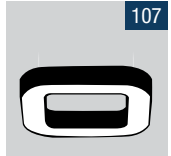









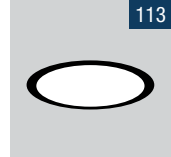
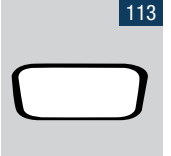















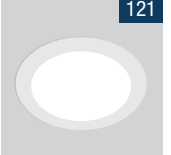



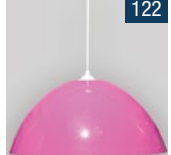

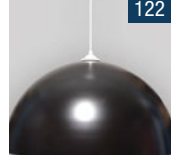
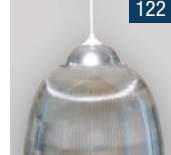





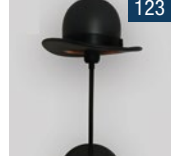



İÇİNDEKİLER

CONTENTS

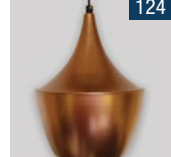
 6	 6	 7	 8	 8	 9	 9	 10
 10	 11	 11	 12	 12	 13	 13	 14
 14	 15	 16	 16	 17	 17	 18	 18
 19	 19	 20	 21	 21	 22	 22	 23
 23	 23	 24	 24	 25	 25	 26	 26
 27	 27	 28	 28	 29	 29	 30	 30
 31	 31	 32	 32	 33	 33	 34	 34
 35	 35	 36	 36	 37	 37	 38	 38

İçindekiler / Contents

 GM451L01	 GM451L31	 GM054L01	 GM054L03	 GM054L04	 GM054L05	 GM054L06	 GM054L07
 GM054L09	 GM054L10	 GM054L11	 GM054L12	 GM054L13	 GM054L14	 GM054L15	 GM054L17
 GM054L18	 GM054L20	 GM054L21	 GM054L22	 GM054L25	 GM054L26	 GM054L27	 GM054L29
 GM054L30	 GM054L31	 GM054L32	 GM054L36	 GM954L01	 GM954L02	 GM954L03	 GM954L05
 GM954L06	 GM954L07	 GM954L08	 GM954L10	 GM954L11	 GM954L12	 GM954L13	 GM954L15
 GM954L16	 GM954L17	 GM954L18	 GM954L21	 GM954L22	 GM954L23	 GM954L24	 GM954L26
 GM954L27	 GM300L01	 GM300L02	 GM300L03	 GM300L04	 GM300L05	 GM300L06	 GM300L07
 GM300L08	 GM300L09	 GM109L01	 GM109L02	 GM109L03	 GM109L04	 GM109L05	 GM109L06
 GM109L07	 GM109L08	 GM109L09	 GM109L10	 GM109L11	 GM109L12	 GM109L13	 GM109L14

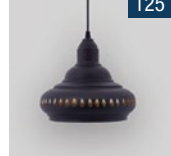
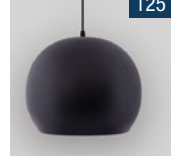
 101	 101	 102	 102	 103	 103	 104	 104
 105	 105	 106	 106	 107	 107	 108	 108
 109	 109	 110	 111	 111	 112	 112	 113
 113	 114	 114	 115	 115	 116	 116	 117
 117	 118	 118	 118	 119	 119	 120	 120
 121	 122	 122	 122	 122	 122	 122	 122
 122	 122	 122	 123	 123	 123	 123	 123
 123	 124	 124	 124	 124	 124	 124	 124
 124	 124	 125	 125	 125	 125	 125	 125

İçindekiler / Contents

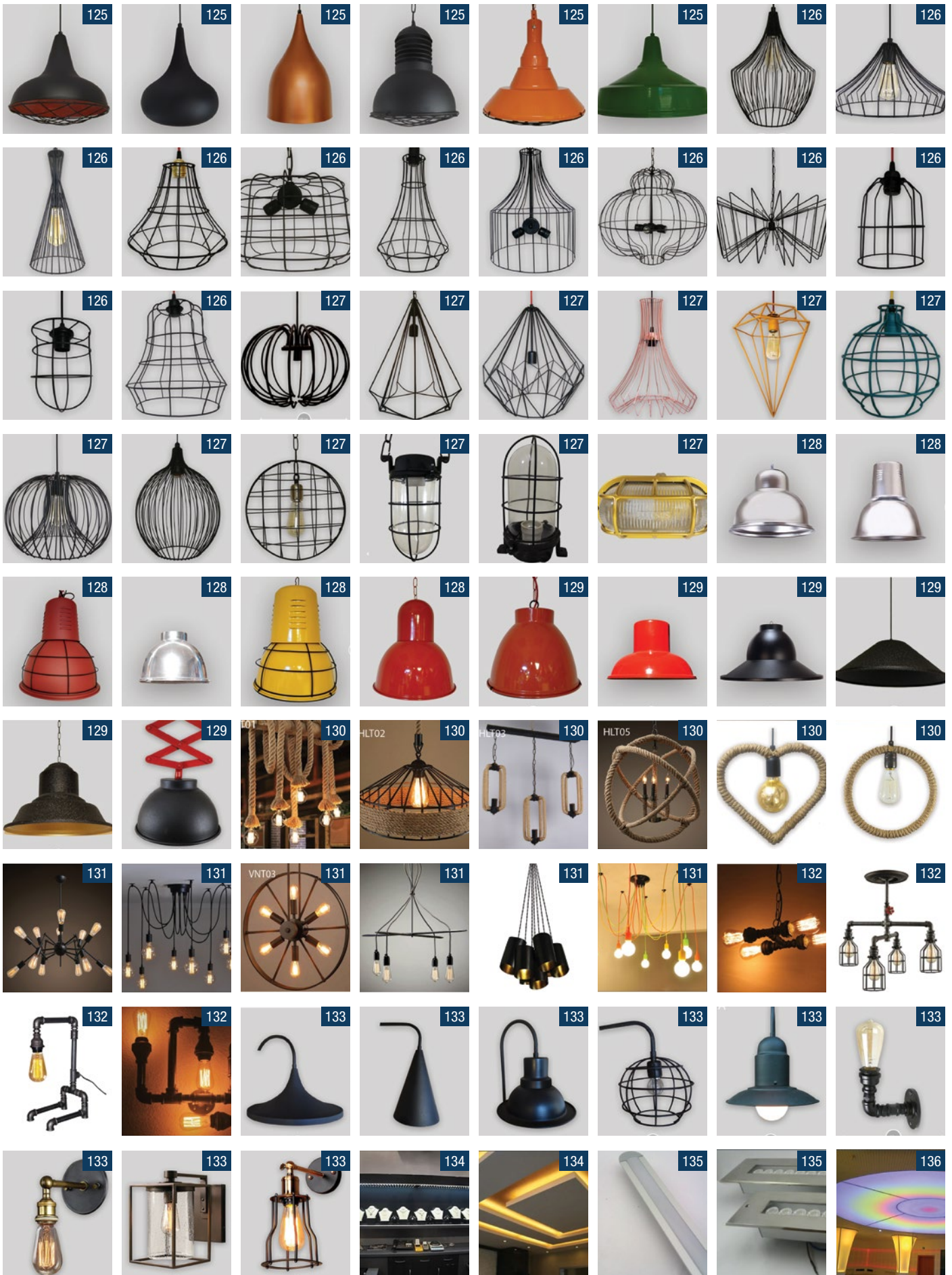



DIŞ AYDINLATMALAR
OUTDOOR LIGHTING



Led Tipi Led Type	Renk Isısı Color Temperature	Toplam Güç Total Power	Akım Current	Voltaj Voltage	Toplam Lümen Total Lumen
Middle Power LED	3000K	11W	116mA	220V AC	953lm
Middle Power LED	4000K	11W	116mA	220V AC	1044lm

Malzeme : Alüminyum enjeksiyon gövde ve pres cam

Renk : Füme, Metalik Gri, Siyah

Armatürün yüzeyine elektrostatik toz boyadan önce korozyon direncini arttırıcı zincoprım uygulanır
LED sürücüsü dahil

Material : Die-cast aluminium body and presses glass

Color : Graphite, Metalik Grey, Black

For corrosion resistance, zincoprım applied to surface of the luminarie before elektrostatik powder coating With LED driver

GM453L53

POWER LED



IP 44



Led Tipi Led Type	Renk Isısı Color Temperature	Toplam Güç Total Power	Akım Current	Voltaj Voltage	Toplam Lümen Total Lumen
Power LED	3000K	2,5W	500mA	220V AC	2X474lm
Power LED	4000K	2,5W	500mA	220V AC	2X529lm
Power LED	6500K	2,5W	500mA	220V AC	2X596lm

Malzeme : Alüminyum profil ve enjeksiyon gövde, ısıya dayanıklı cam ve optik lens

Renk : Füme, Metalik Gri, Siyah

Armatürün yüzeyine elektrostatik toz boyadan önce korozyon direncini arttırıcı zincoprım uygulanır
LED sürücüsü dahil

Material : Die-cast aluminium and extruded body, tempered glass and optic lens

Color : Graphite, Metalik Grey, Black

For corrosion resistance, zincoprım applied to surface of the luminarie before elektrostatik powder coating With LED driver

GM453L32

POWER LED

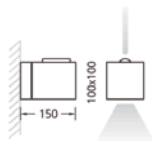

IP 65





Led Tipi Led Type	Renk Isısı Color Temperature	Toplam Güç Total Power	Akım Current	Voltaj Voltage	Toplam Lümen Total Lumen
Power LED	3000K	2X10W	500mA	220V AC	2X948lm
Power LED	4000K	2X10W	500mA	220V AC	2X1058lm
Power LED	6500K	2X10W	500mA	220V AC	2X1192lm

Malzeme : Alüminyum profil ve enjeksiyon gövde, ısıya dayanıklı cam ve optik lens

Renk : Füme, Metalik Gri, Siyah

Armatürün yüzeyine elektrostatik toz boyadan önce korozyon direncini artırıcı zincoprım uygulanır
LED sürücüsü dahil

Material : Die-cast aluminium and extruded body, tempered glass and optic lens

Color : Graphite, Metalik Grey, Black

For corrosion resistance, zincoprım applied to surface of the luminarie before elektrostatik powder coating With LED driver

GM453L37

POWER LED

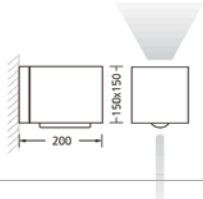

IP 65





Led Tipi Led Type	LED Rengi LED Color	Toplam Güç Total Power	Voltaj Voltage	Renk Isısı Color Temperature	Toplam Lümen Total Lumen
Osram Power LED	Ilık Beyaz/Warm White	5.5W	220-240V	3000K	200
Osram Power LED	Soğuk Beyaz/Cool White	5.5W	220-240V	6500K	230

Malzeme : Alüminyum enjeksiyon gövde, ısıya dayanıklı cam

Renk : Füme, Metalik Gri, Siyah

Armatürün yüzeyine elektrostatik toz boyadan önce korozyon direncini artırıcı zincoprım uygulanır
LED sürücüsü dahil

Material : Die-cast aluminium body, tempered glass

Color : Graphite, Metallic Grey, Black

For corrosion resistance, zincoprım applied to surface of the luminaire before electrostatic powder coating With LED driver

GM053L01

POWER LED 1X5 5W. GU10

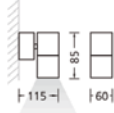

IP 65



Led Tipi Led Type	LED Rengi LED Color	Toplam Güç Total Power	Voltaj Voltage	Renk Isısı Color Temperature	Toplam Lümen Total Lumen
Osram Power LED	Ilık Beyaz/Warm White	11W	220-240V	3000K	400
Osram Power LED	Soğuk Beyaz/Cool White	11W	220-240V	6500K	460

Malzeme : Alüminyum enjeksiyon gövde, ısıya dayanıklı cam

Renk : Füme, Metalik Gri, Siyah

Armatürün yüzeyine elektrostatik toz boyadan önce korozyon direncini artırıcı zincoprım uygulanır
LED sürücüsü dahil

Material : Die-cast aluminium body, tempered glass

Color : Graphite, Metallic Grey, Black

For corrosion resistance, zincoprım applied to surface of the luminaire before electrostatic powder coating With LED driver

GM053L02

POWER LED 2X5.5W. GU10

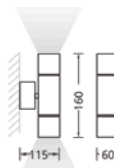

IP 65





Led Tipi Led Type	Renk Isısı Color Temperature	Toplam Güç Total Power	Akım Current	Voltaj Voltage	Toplam Lümen Total Lumen
Power LED	3000K	5W	500mA	220V AC	474lm
Power LED	4000K	5W	500mA	220V AC	529lm
Power LED	6500K	5W	500mA	220V AC	596lm

Malzeme : Alüminyum profil ve enjeksiyon gövde, ısıya dayanıklı cam

Renk : Füme, Metalik Gri, Siyah

Armatürün yüzeyine elektrostatik toz boyadan önce korozyon direncini artırıcı zincoprım uygulanır
LED sürücüsü dahil

Material : Die-cast aluminium and extruded body, tempered glass

Color : Graphite, Metalik Grey, Black

For corrosion resistance, zincoprım applied to surface of the luminarie before elektrostatik powder coating With LED driver

GM453L10

1 X POWER LED

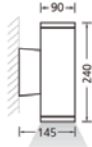

IP 65



Led Tipi Led Type	Renk Isısı Color Temperature	Toplam Güç Total Power	Akım Current	Voltaj Voltage	Toplam Lümen Total Lumen
Power LED	3000K	2X5W	500mA	220V AC	2X474lm
Power LED	4000K	2X5W	500mA	220V AC	2X529lm
Power LED	6500K	2X5W	500mA	220V AC	2X596lm

Malzeme : Alüminyum profil ve enjeksiyon gövde, ısıya dayanıklı cam

Renk : Füme, Metalik Gri, Siyah

Armatürün yüzeyine elektrostatik toz boyadan önce korozyon direncini artırıcı zincoprım uygulanır
LED sürücüsü dahil

Material : Die-cast aluminium and extruded body, tempered glass

Color : Graphite, Metalik Grey, Black

For corrosion resistance, zincoprım applied to surface of the luminarie before elektrostatik powder coating With LED driver

GM453L11

2 X POWER LED

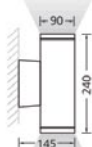

IP 65





Led Tipi Led Type	Renk Isısı Color Temperature	Toplam Güç Total Power	Akım Current	Voltaj Voltage	Toplam Lümen Total Lumen
Power LED	3000K	10W	500mA	220V AC	948lm
Power LED	4000K	10W	500mA	220V AC	1058lm
Power LED	6500K	10W	500mA	220V AC	1192lm
Led Tipi Led Type	Renk Isısı Color Temperature	Toplam Güç Total Power	Akım Current	Voltaj Voltage	Toplam Lümen Total Lumen
Power LED	3000K	15W	500mA	220V AC	1422lm
Power LED	4000K	15W	500mA	220V AC	1587lm
Power LED	6500K	15W	500mA	220V AC	1788lm

Malzeme : Alüminyum profil ve enjeksiyon gövde, ısıya dayanıklı cam

Renk : Füme, Metalik Gri, Siyah

Armatürün yüzeyine elektrostatik toz boyadan önce korozyon direncini arttırıcı zincoprım uygulanır LED sürücüsü dahil

Material : Die-cast aluminium and extruded body, tempered glass

Color : Graphite, Metalik Grey, Black

For corrosion resistance, zincoprım applied to surface of the luminarie before elektrostatik powder coating With LED driver

GM453L02	GM453L13
1 X 10W. POWER LED	1 X 15W. POWER LED

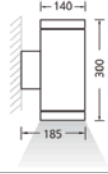

IP 65



Led Tipi Led Type	Renk Isısı Color Temperature	Toplam Güç Total Power	Akım Current	Voltaj Voltage	Toplam Lümen Total Lumen
Power LED	3000K	2X10W	500mA	220V AC	2X948lm
Power LED	4000K	2X10W	500mA	220V AC	2X1058lm
Power LED	6500K	2X10W	500mA	220V AC	2X1192lm
Led Tipi Led Type	Renk Isısı Color Temperature	Toplam Güç Total Power	Akım Current	Voltaj Voltage	Toplam Lümen Total Lumen
Power LED	3000K	2X15W	500mA	220V AC	2X1422lm
Power LED	4000K	2X15W	500mA	220V AC	2X1587lm
Power LED	6500K	2X15W	500mA	220V AC	2X1788lm

Malzeme : Alüminyum profil ve enjeksiyon gövde, ısıya dayanıklı cam

Renk : Füme, Metalik Gri, Siyah

Armatürün yüzeyine elektrostatik toz boyadan önce korozyon direncini arttırıcı zincoprım uygulanır LED sürücüsü dahil

Material : Die-cast aluminium and extruded body, tempered glass

Color : Graphite, Metalik Grey, Black

For corrosion resistance, zincoprım applied to surface of the luminarie before elektrostatik powder coating With LED driver

GM453L03	GM453L14
2 X 10W. POWER LED	2 X 15W. POWER LED



IP 65





Led Tipi Led Type	Renk Isısı Color Temperature	Toplam Güç Total Power	Akım Current	Voltaj Voltage	Toplam Lümen Total Lumen
Middle Power LED	3000K	7W	116mA	220V AC	715lm
Middle Power LED	4000K	7W	116mA	220V AC	784lm

Malzeme : Paslanmaz çelik ön kapak ve plastik enjeksiyon gövde, asimetrik alüminyum reflektör ve ısıya dayanıklı cam
Renk : Füme, Metalik Gri, Siyah
 Armatürün yüzeyine elektrostatik toz boyadan önce korozyon direncini artırıcı zincoprım uygulanır LED sürücüsü dahil

Material : Stainless-stel front frame and plastic injection body, asymmetric alüminium reflector and tempered glass
Color : Graphite, Metalik Grey, Black
 For corrosion resistance, zincoprım applied to surface of the luminarie before elektrostatik powder coating With LED driver

GM453L30	MIDDLE POWER LED	90 1	193	193	⊕	IP 65	F	PG	CE



Led Tipi Led Type	Renk Isısı Color Temperature	Toplam Güç Total Power	Akım Current	Voltaj Voltage	Toplam Lümen Total Lumen
Middle Power LED	3000K	11W	116mA	220V AC	953lm
Middle Power LED	4000K	11W	116mA	220V AC	1044lm

Malzeme : Paslanmaz çelik ön kapak ve plastik enjeksiyon gövde, asimetrik alüminyum reflektör ve ısıya dayanıklı cam
Renk : Füme, Metalik Gri, Siyah
 Armatürün yüzeyine elektrostatik toz boyadan önce korozyon direncini artırıcı zincoprım uygulanır LED sürücüsü dahil

Material : Stainless-stel front frame and plastic injection body, asymmetric alüminium reflector and tempered glass
Color : Graphite, Metalik Grey, Black
 For corrosion resistance, zincoprım applied to surface of the luminarie before elektrostatik powder coating With LED driver

GM453L31	MIDDLE POWER LED	90 1	264	210	⊕	IP 65	F	PG	CE



Led Tipi Led Type	Renk Isısı Color Temperature	Toplam Güç Total Power	Akım Current	Voltaj Voltage	Toplam Lümen Total Lumen
Power LED	3000K	45W	700mA	220V AC	3687lm
Power LED	4000K	45W	700mA	220V AC	4140lm
Power LED	6500K	45W	700mA	220V AC	4630lm

Malzeme : Alüminyum profil ve enjeksiyon gövde, ısıya dayanıklı cam

Renk : Füme, Metalik Gri, Siyah

Armatürün yüzeyine elektrostatik toz boyadan önce korozyon direncini artırıcı zincoprım uygulanır
LED sürücüsü dahil

Material : Die-cast aluminium and extruded body, tempered glass

Color : Graphite, Metalik Grey, Black

For corrosion resistance, zincoprım applied to surface of the luminarie before elektrostatik powder coating With LED driver

GM453L16

1 X POWER LED

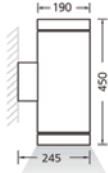

IP 65



Led Tipi Led Type	Renk Isısı Color Temperature	Toplam Güç Total Power	Akım Current	Voltaj Voltage	Toplam Lümen Total Lumen
Power LED	3000K	2X45W	700mA	220V AC	3687lm
Power LED	4000K	2X45W	700mA	220V AC	4140lm
Power LED	6500K	2X45W	700mA	220V AC	4630lm

Malzeme : Alüminyum profil ve enjeksiyon gövde, ısıya dayanıklı cam

Renk : Füme, Metalik Gri, Siyah

Armatürün yüzeyine elektrostatik toz boyadan önce korozyon direncini artırıcı zincoprım uygulanır
LED sürücüsü dahil

Material : Die-cast aluminium and extruded body, tempered glass

Color : Graphite, Metalik Grey, Black

For corrosion resistance, zincoprım applied to surface of the luminarie before elektrostatik powder coating With LED driver

GM453L17

2 X POWER LED

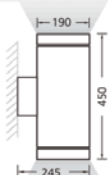

IP 65





Led Tipi Led Type	Renk Isısı Color Temperature	Toplam Güç Total Power	Akım Current	Voltaj Voltage	Toplam Lümen Total Lumen
Power LED	3000K	10W	500mA	220V AC	948lm
Power LED	4000K	10W	500mA	220V AC	1058lm
Power LED	6500K	10W	500mA	220V AC	1192lm

Malzeme : Alüminyum profil ve enjeksiyon gövde, ısıya dayanıklı cam

Renk : Füme, Metalik Gri, Siyah

Armatürün yüzeyine elektrostatik toz boyadan önce korozyon direncini artırıcı zincoprım uygulanır
LED sürücüsü dahil

Material : Die-cast aluminium and extruded body, tempered glass

Color : Graphite, Metalik Grey, Black

For corrosion resistance, zincoprım applied to surface of the luminarie before elektrostatik powder coating With LED driver

GM453L19

1 X POWER LED

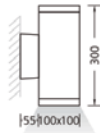

IP 65



Led Tipi Led Type	Renk Isısı Color Temperature	Toplam Güç Total Power	Akım Current	Voltaj Voltage	Toplam Lümen Total Lumen
Power LED	3000K	2X10W	500mA	220V AC	2X948lm
Power LED	4000K	2X10W	500mA	220V AC	2X1058lm
Power LED	6500K	2X10W	500mA	220V AC	2X1192lm

Malzeme : Alüminyum profil ve enjeksiyon gövde, ısıya dayanıklı cam

Renk : Füme, Metalik Gri, Siyah

Armatürün yüzeyine elektrostatik toz boyadan önce korozyon direncini artırıcı zincoprım uygulanır
LED sürücüsü dahil

Material : Die-cast aluminium and extruded body, tempered glass

Color : Graphite, Metalik Grey, Black

For corrosion resistance, zincoprım applied to surface of the luminarie before elektrostatik powder coating With LED driver

GM453L20

2 X POWER LED



IP 65





Led Tipi Led Type	Renk Isısı Color Temperature	Toplam Güç Total Power	Akım Current	Voltaj Voltage	Toplam Lümen Total Lumen
Power LED	3000K	20W	500mA	220V AC	1896lm
Power LED	4000K	20W	500mA	220V AC	2116lm
Power LED	6500K	20W	500mA	220V AC	2384lm
Led Tipi Led Type	Renk Isısı Color Temperature	Toplam Güç Total Power	Akım Current	Voltaj Voltage	Toplam Lümen Total Lumen
Power LED	3000K	30W	700mA	220V AC	2458lm
Power LED	4000K	30W	700mA	220V AC	2760lm
Power LED	6500K	30W	700mA	220V AC	3087lm

Malzeme : Alüminyum profil ve enjeksiyon gövde, ısıya dayanıklı cam

Renk : Füme, Metalik Gri, Siyah

Armatürün yüzeyine elektrostatik toz boyadan önce korozyon direncini artırıcı zincoprım uygulanır LED sürücüsü dahil

Material : Die-cast aluminium and extruded body, tempered glass

Color : Graphite, Metalik Grey, Black

For corrosion resistance, zincoprım applied to surface of the luminarie before elektrostatik powder coating With LED driver

GM453L22	GM453L55
1 X 20W. POWER LED	1 X 30W. POWER LED

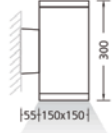

IP 65



Led Tipi Led Type	Renk Isısı Color Temperature	Toplam Güç Total Power	Akım Current	Voltaj Voltage	Toplam Lümen Total Lumen
Power LED	3000K	2X20W	500mA	220V AC	2X1896lm
Power LED	4000K	2X20W	500mA	220V AC	2X2116lm
Power LED	6500K	2X20W	500mA	220V AC	2X2384lm
Led Tipi Led Type	Renk Isısı Color Temperature	Toplam Güç Total Power	Akım Current	Voltaj Voltage	Toplam Lümen Total Lumen
Power LED	3000K	2X30W	700mA	220V AC	2X2458lm
Power LED	4000K	2X30W	700mA	220V AC	2X2760lm
Power LED	6500K	2X30W	700mA	220V AC	2X3087lm

Malzeme : Alüminyum profil ve enjeksiyon gövde, ısıya dayanıklı cam

Renk : Füme, Metalik Gri, Siyah

Armatürün yüzeyine elektrostatik toz boyadan önce korozyon direncini artırıcı zincoprım uygulanır LED sürücüsü dahil

Material : Die-cast aluminium and extruded body, tempered glass

Color : Graphite, Metalik Grey, Black

For corrosion resistance, zincoprım applied to surface of the luminarie before elektrostatik powder coating With LED driver

GM453L23	GM453L56
2 X 20W. POWER LED	2 X 30W. POWER LED

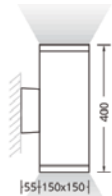

IP 65





Malzeme : Alüminyum profil ve enjeksiyon gövde, ısıya dayanıklı cam
Renk : Füme, Metalik Gri, Siyah
 Armatürün yüzeyine elektrostatik toz boyadan önce korozyon direncini arttırıcı zincoprım uygulanır
 LED sürücüsü dahil

Material : Die-cast aluminium and extruded body, tempered glass
Color : Graphite, Metallik Grey, Black
 For corrosion resistance, zincoprım applied to surface of the luminaire before elektrostatik powder coating
 With LED driver



IP 67

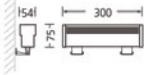
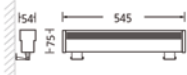
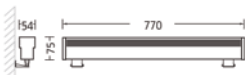
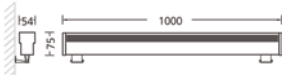

GM453L05		Led Tipi Led Type	Renk Isısı Color Temperature	Toplam Güç Total Power	Akım Current	Voltaj Voltage	Toplam Lümen Total Lumen
9 X POWER LED		Power LED	3000K	10W	350mA	220V AC	1053lm
		Power LED	4000K	10W	350mA	220V AC	1134lm
		Power LED	6500K	10W	350mA	220V AC	1323lm
GM453L06		Led Tipi Led Type	Renk Isısı Color Temperature	Toplam Güç Total Power	Akım Current	Voltaj Voltage	Toplam Lümen Total Lumen
18 X POWER LED		Power LED	3000K	21W	350mA	220V AC	2106lm
		Power LED	4000K	21W	350mA	220V AC	2268lm
		Power LED	6500K	21W	350mA	220V AC	2646lm
GM453L07		Led Tipi Led Type	Renk Isısı Color Temperature	Toplam Güç Total Power	Akım Current	Voltaj Voltage	Toplam Lümen Total Lumen
27 X POWER LED		Power LED	3000K	32W	350mA	220V AC	3159lm
		Power LED	4000K	32W	350mA	220V AC	3402lm
		Power LED	6500K	32W	350mA	220V AC	3969lm
GM453L08		Led Tipi Led Type	Renk Isısı Color Temperature	Toplam Güç Total Power	Akım Current	Voltaj Voltage	Toplam Lümen Total Lumen
36 X POWER LED		Power LED	3000K	42W	350mA	220V AC	4212lm
		Power LED	4000K	42W	350mA	220V AC	4536lm
		Power LED	6500K	42W	350mA	220V AC	5292lm

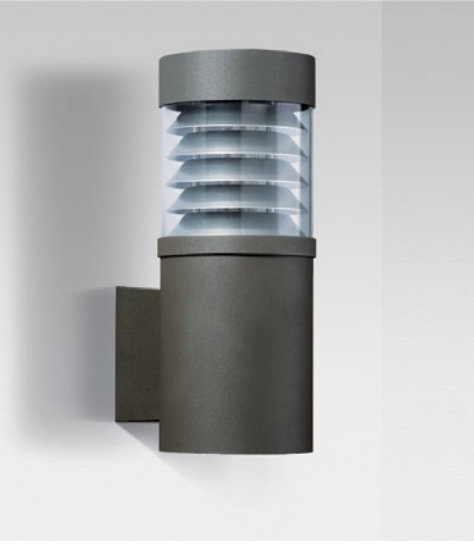

Led Tipi Led Type	Renk Isısı Color Temperature	Toplam Güç Total Power	Akım Current	Voltaj Voltage	Toplam Lümen Total Lumen
Middle Power LED	3000K	22W	116mA	220V AC	1905lm
Middle Power LED	4000K	22W	116mA	220V AC	2087lm

Malzeme : Alüminyum profil ve enjeksiyon gövde, polikarbonat difüzör

Renk : Füme, Metalik Gri, Siyah

Armatürün yüzeyine elektrostatik toz boyadan önce korozyon direncini artırıcı zincoprim uygulanır LED sürücüsü dahil

Material : Die-cast aluminium and extruded body, polycarbonate diffuser

Color : Graphite, Metalik Grey, Black

For corrosion resistance, zincoprim applied to surface of the luminarie before electrostatik powder coating With LED driver

GM453L33

MIDDLE POWER LED

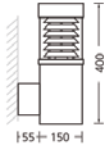

IP 65



Led Tipi Led Type	Renk Isısı Color Temperature	Toplam Güç Total Power	Akım Current	Voltaj Voltage	Toplam Lümen Total Lumen
Middle Power LED	3000K	22W	116mA	220V AC	1905lm
Middle Power LED	4000K	22W	116mA	220V AC	2087lm

Malzeme : Alüminyum profil ve enjeksiyon gövde, polikarbonat difüzör

Renk : Füme, Metalik Gri, Siyah

Armatürün yüzeyine elektrostatik toz boyadan önce korozyon direncini artırıcı zincoprim uygulanır LED sürücüsü dahil

Material : Die-cast aluminium and extruded body, polycarbonate diffuser

Color : Graphite, Metalik Grey, Black

For corrosion resistance, zincoprim applied to surface of the luminarie before electrostatik powder coating With LED driver

GM453L34

MIDDLE POWER LED



IP 65





Led Tipi Led Type	Renk Isısı Color Temperature	Toplam Güç Total Power	Akım Current	Voltaj Voltage	Toplam Lümen Total Lumen
Middle Power LED	3000K	22W	116mA	220V AC	1905lm
Middle Power LED	4000K	22W	116mA	220V AC	2087lm

Malzeme : Alüminyum profil ve enjeksiyon gövde, alüminyum reflektör ve polikarbonat difüzör

Renk : Füme, Metalik Gri, Siyah

Armatürün yüzeyine elektrostatik toz boyadan önce korozyon direncini artırıcı zincoprım uygulanır
LED sürücüsü dahil

Material : Die-cast aluminium and extruded body, aluminium reflector and polycarbonate diffuser

Color : Graphite, Metalik Grey, Black

For corrosion resistance, zincoprım applied to surface of the luminarie before elektrostatik powder coating With LED driver

GM453L38

MIDDLE POWER LED



IP 65



Led Tipi Led Type	Renk Isısı Color Temperature	Toplam Güç Total Power	Akım Current	Voltaj Voltage	Toplam Lümen Total Lumen
Middle Power LED	3000K	22W	116mA	220V AC	1905lm
Middle Power LED	4000K	22W	116mA	220V AC	2087lm

Malzeme : Alüminyum profil ve enjeksiyon gövde, polikarbonat difüzör

Renk : Füme, Metalik Gri, Siyah

Armatürün yüzeyine elektrostatik toz boyadan önce korozyon direncini artırıcı zincoprım uygulanır
LED sürücüsü dahil

Material : Die-cast aluminium and extruded body, polycarbonate diffuser

Color : Graphite, Metalik Grey, Black

For corrosion resistance, zincoprım applied to surface of the luminarie before elektrostatik powder coating With LED driver

GM453L39

MIDDLE POWER LED



IP 65





Led Tipi Led Type	Renk Isısı Color Temperature	Toplam Güç Total Power	Akım Current	Voltaj Voltage	Toplam Lümen Total Lumen
Power LED	3000K	15W	500mA	220V AC	1422lm
Power LED	4000K	15W	500mA	220V AC	1587lm
Power LED	6500K	15W	500mA	220V AC	1788lm

Malzeme : Alüminyum profil ve enjeksiyon gövde, akrilik difüzör

Renk : Füme, Metalik Gri, Siyah

Armatürün yüzeyine elektrostatik toz boyadan önce korozyon direncini artırıcı zincoprım uygulanır LED sürücüsü dahil

Material : Die-cast aluminium and extruded body, acrylic diffuser

Color : Graphite, Metalik Grey, Black

For corrosion resistance, zincoprım applied to surface of the luminarie before elektrostatik powder coating With LED driver

GM454L07

POWER LED



IP 65



Led Tipi Led Type	Renk Isısı Color Temperature	Toplam Güç Total Power	Akım Current	Voltaj Voltage	Toplam Lümen Total Lumen
Middle Power LED	3000K	22W	116mA	220V AC	1905lm
Middle Power LED	4000K	22W	116mA	220V AC	2087lm

Malzeme : Alüminyum enjeksiyon gövde ve pres cam

Renk : Füme, Metalik Gri, Siyah

Armatürün yüzeyine elektrostatik toz boyadan önce korozyon direncini artırıcı zincoprım uygulanır LED sürücüsü dahil

Material : Die-cast aluminium body and pressed glass

Color : Graphite, Metalik Grey, Black

For corrosion resistance, zincoprım applied to surface of the luminarie before elektrostatik powder coating With LED driver

GM454L08

MIDDLE POWER LED

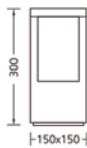

IP 65





Led Tipi Led Type	Renk Isısı Color Temperature	Toplam Güç Total Power	Akım Current	Voltaj Voltage	Toplam Lümen Total Lumen
Middle Power LED	3000K	22W	116mA	220V AC	1905lm
Middle Power LED	4000K	22W	116mA	220V AC	2087lm

Malzeme : Alüminyum profil ve enjeksiyon gövde, alüminyum reflektör ve akrilik difüzör

Renk : Füme, Metalik Gri, Siyah

Armatürün yüzeyine elektrostatik toz boyadan önce korozyon direncini artırıcı zincoprım uygulanır
LED sürücüsü dahil

Material : Die-cast aluminium and extruded body, aluminium reflector and acrylic diffuser

Color : Graphite, Metalik Grey, Black

For corrosion resistance, zincoprım applied to surface of the luminarie before elektrostatik powder coating With LED driver

GM454L21

MIDDLE POWER LED



IP 65



Led Tipi Led Type	Renk Isısı Color Temperature	Toplam Güç Total Power	Akım Current	Voltaj Voltage	Toplam Lümen Total Lumen
Power LED	3000K	15W	500mA	220V AC	1422lm
Power LED	4000K	15W	500mA	220V AC	1587lm
Power LED	6500K	15W	500mA	220V AC	1788lm

Malzeme : Alüminyum profil ve enjeksiyon gövde, akrilik difüzör

Renk : Füme, Metalik Gri, Siyah

Armatürün yüzeyine elektrostatik toz boyadan önce korozyon direncini artırıcı zincoprım uygulanır
LED sürücüsü dahil

Material : Die-cast aluminium and extruded body, acrylic diffuser

Color : Graphite, Metalik Grey, Black

For corrosion resistance, zincoprım applied to surface of the luminarie before elektrostatik powder coating With LED driver

GM454L24

POWER LED

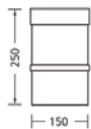

IP 65





Led Tipi Led Type	Renk Isısı Color Temperature	Toplam Güç Total Power	Akım Current	Voltaj Voltage	Toplam Lümen Total Lumen
Power LED	3000K	15W	500mA	220V AC	1422lm
Power LED	4000K	15W	500mA	220V AC	1587lm
Power LED	6500K	15W	500mA	220V AC	1788lm

Malzeme : Alüminyum profil ve enjeksiyon gövde, alüminyum reflektor ve akrilik difüzör

Renk : Füme, Metalik Gri, Siyah

Armatürün yüzeyine elektrostatik toz boyadan önce korozyon direncini artırıcı zincoprım uygulanır
LED sürücüsü dahil

Material : Die-cast aluminium and extruded body, aluminium reflector and acrylic diffuser

Color : Graphite, Metalik Grey, Black

For corrosion resistance, zincoprım applied to surface of the luminarie before elektrostatik powder coating With LED driver

GM454L27

POWER LED



IP 65





Led Tipi Led Type	Renk Isısı Color Temperature	Toplam Güç Total Power	Akım Current	Voltaj Voltage	Toplam Lümen Total Lumen
Power LED	3000K	5W	500mA	220V AC	474lm
Power LED	4000K	5W	500mA	220V AC	529lm
Power LED	6500K	5W	500mA	220V AC	596lm

Malzeme : Alüminyum enjeksiyon gövde ve ısıya dayanıklı cam

Renk : Füme, Metalik Gri, Siyah

Armatürün yüzeyine elektrostatik toz boyadan önce korozyon direncini artırıcı zincoprım uygulanır LED sürücüsü dahil

Material : Die-cast aluminium body and tempered glass

Color : Graphite, Metalik Grey, Black

For corrosion resistance, zincoprım applied to surface of the luminarie before elektrostatik powder coating With LED driver

GM454L03

POWER LED

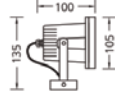

IP 65



Led Tipi Led Type	Renk Isısı Color Temperature	Toplam Güç Total Power	Akım Current	Voltaj Voltage	Toplam Lümen Total Lumen
Power LED	3000K	5W	500mA	220V AC	474lm
Power LED	4000K	5W	500mA	220V AC	529lm
Power LED	6500K	5W	500mA	220V AC	596lm

Malzeme : Alüminyum enjeksiyon gövde ve ısıya dayanıklı cam

Renk : Füme, Metalik Gri, Siyah

Armatürün yüzeyine elektrostatik toz boyadan önce korozyon direncini artırıcı zincoprım uygulanır LED sürücüsü dahil

Material : Die-cast aluminium body and tempered glass

Color : Graphite, Metalik Grey, Black

For corrosion resistance, zincoprım applied to surface of the luminarie before elektrostatik powder coating With LED driver

GM454L04

POWER LED

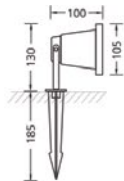

IP 65





Led Tipi Led Type	Renk Isısı Color Temperature	Toplam Güç Total Power	Akım Current	Voltaj Voltage	Toplam Lümen Total Lumen
Power LED	3000K	5W	500mA	220V AC	474lm
Power LED	4000K	5W	500mA	220V AC	529lm
Power LED	6500K	5W	500mA	220V AC	596lm

Malzeme : Alüminyum enjeksiyon gövde ve ısıya dayanıklı cam

Renk : Füme, Metalik Gri, Siyah

Armatürün yüzeyine elektrostatik toz boyadan önce korozyon direncini artırıcı zincoprım uygulanır LED sürücüsü dahil

Material : Die-cast aluminium body and tempered glass

Color : Graphite, Metalik Grey, Black

For corrosion resistance, zincoprım applied to surface of the luminarie before elektrostatik powder coating With LED driver

GM454L12

POWER LED

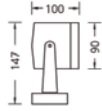

IP 65



Led Tipi Led Type	Renk Isısı Color Temperature	Toplam Güç Total Power	Akım Current	Voltaj Voltage	Toplam Lümen Total Lumen
Power LED	3000K	5W	500mA	220V AC	474lm
Power LED	4000K	5W	500mA	220V AC	529lm
Power LED	6500K	5W	500mA	220V AC	596lm

Malzeme : Alüminyum enjeksiyon gövde ve ısıya dayanıklı cam

Renk : Füme, Metalik Gri, Siyah

Armatürün yüzeyine elektrostatik toz boyadan önce korozyon direncini artırıcı zincoprım uygulanır LED sürücüsü dahil

Material : Die-cast aluminium body and tempered glass

Color : Graphite, Metalik Grey, Black

For corrosion resistance, zincoprım applied to surface of the luminarie before elektrostatik powder coating With LED driver

GM454L09

POWER LED

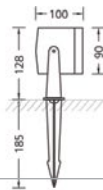

IP 65





Led Tipi Led Type	Renk Isısı Color Temperature	Toplam Güç Total Power	Akım Current	Voltaj Voltage	Toplam Lümen Total Lumen
Power LED	3000K	10W	500mA	220V AC	948lm
Power LED	4000K	10W	500mA	220V AC	1058lm
Power LED	6500K	10W	500mA	220V AC	1192lm

Malzeme : Alüminyum enjeksiyon gövde ve ısıya dayanıklı cam

Renk : Füme, Metalik Gri, Siyah

Armatürün yüzeyine elektrostatik toz boyadan önce korozyon direncini artırıcı zincoprım uygulanır LED sürücüsü dahil

Material : Die-cast aluminium body and tempered glass

Color : Graphite, Metalik Grey, Black

For corrosion resistance, zincoprım applied to surface of the luminarie before elektrostatik powder coating With LED driver

GM454L13

POWER LED

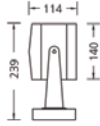

IP 65



Led Tipi Led Type	Renk Isısı Color Temperature	Toplam Güç Total Power	Akım Current	Voltaj Voltage	Toplam Lümen Total Lumen
Power LED	3000K	10W	500mA	220V AC	948lm
Power LED	4000K	10W	500mA	220V AC	1058lm
Power LED	6500K	10W	500mA	220V AC	1192lm

Malzeme : Alüminyum enjeksiyon gövde ve ısıya dayanıklı cam

Renk : Füme, Metalik Gri, Siyah

Armatürün yüzeyine elektrostatik toz boyadan önce korozyon direncini artırıcı zincoprım uygulanır LED sürücüsü dahil

Material : Die-cast aluminium body and tempered glass

Color : Graphite, Metalik Grey, Black

For corrosion resistance, zincoprım applied to surface of the luminarie before elektrostatik powder coating With LED driver

GM454L10

POWER LED

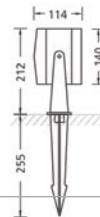

IP 65





Led Tipi Led Type	Renk Isısı Color Temperature	Toplam Güç Total Power	Akım Current	Voltaj Voltage	Toplam Lümen Total Lumen
Power LED	3000K	15W	700mA	220V AC	1422lm
Power LED	4000K	15W	700mA	220V AC	1587lm
Power LED	6500K	15W	700mA	220V AC	1788lm

Malzeme : Alüminyum enjeksiyon gövde ve ısıya dayanıklı cam

Renk : Füme, Metalik Gri, Siyah

Armatürün yüzeyine elektrostatik toz boyadan önce korozyon direncini artırıcı zincoprim uygulanır LED sürücüsü dahil

Material : Die-cast aluminium body and tempered glass

Color : Graphite, Metalik Grey, Black

For corrosion resistance, zincoprim applied to surface of the luminarie before elektrostatik powder coating With LED driver

GM454L14

POWER LED

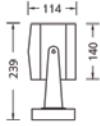

IP 65



Led Tipi Led Type	Renk Isısı Color Temperature	Toplam Güç Total Power	Akım Current	Voltaj Voltage	Toplam Lümen Total Lumen
Power LED	3000K	15W	700mA	220V AC	1422lm
Power LED	4000K	15W	700mA	220V AC	1587lm
Power LED	6500K	15W	700mA	220V AC	1788lm

Malzeme : Alüminyum enjeksiyon gövde ve ısıya dayanıklı cam

Renk : Füme, Metalik Gri, Siyah

Armatürün yüzeyine elektrostatik toz boyadan önce korozyon direncini artırıcı zincoprim uygulanır LED sürücüsü dahil

Material : Die-cast aluminium body and tempered glass

Color : Graphite, Metalik Grey, Black

For corrosion resistance, zincoprim applied to surface of the luminarie before elektrostatik powder coating With LED driver

GM454L11

POWER LED

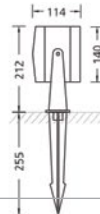

IP 65





Led Tipi Led Type	Renk Isısı Color Temperature	Toplam Güç Total Power	Akım Current	Voltaj Voltage	Toplam Lümen Total Lumen
Power LED	3000K	10W	500mA	220V AC	948lm
Power LED	4000K	10W	500mA	220V AC	1058lm
Power LED	6500K	10W	500mA	220V AC	1192lm

Malzeme : Alüminyum enjeksiyon gövde ve ısıya dayanıklı cam

Renk : Füme, Metalik Gri, Siyah

Armatürün yüzeyine elektrostatik toz boyadan önce korozyon direncini artırıcı zincoprım uygulanır
LED sürücüsü dahil

Material : Die-cast aluminium body and tempered glass

Color : Graphite, Metalik Grey, Black

For corrosion resistance, zincoprım applied to surface of the luminarie before elektrostatik powder coating With LED driver

GM454L05

POWER LED

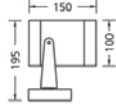

IP 65



Led Tipi Led Type	Renk Isısı Color Temperature	Toplam Güç Total Power	Akım Current	Voltaj Voltage	Toplam Lümen Total Lumen
Power LED	3000K	20W	500mA	220V AC	1896lm
Power LED	4000K	20W	500mA	220V AC	2116lm
Power LED	6500K	20W	500mA	220V AC	2384lm

Malzeme : Alüminyum enjeksiyon gövde ve ısıya dayanıklı cam

Renk : Füme, Metalik Gri, Siyah

Armatürün yüzeyine elektrostatik toz boyadan önce korozyon direncini artırıcı zincoprım uygulanır
LED sürücüsü dahil

Material : Die-cast aluminium body and tempered glass

Color : Graphite, Metalik Grey, Black

For corrosion resistance, zincoprım applied to surface of the luminarie before elektrostatik powder coating With LED driver

GM454L06

POWER LED

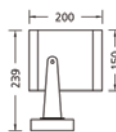

IP 65





Led Tipi Led Type	Renk Isısı Color Temperature	Toplam Güç Total Power	Akım Current	Voltaj Voltage	Toplam Lümen Total Lumen
Power LED	3000K	45W	700mA	220V AC	3687lm
Power LED	4000K	45W	700mA	220V AC	4140lm
Power LED	6500K	45W	700mA	220V AC	4630lm

Malzeme : Alüminyum enjeksiyon gövde ve ısıya dayanıklı cam

Renk : Füme, Metalik Gri, Siyah

Armatürün yüzeyine elektrostatik toz boyadan önce korozyon direncini artırıcı zincoprım uygulanır
LED sürücüsü dahil

Material : Die-cast aluminium body and tempered glass

Color : Graphite, Metalik Grey, Black

For corrosion resistance, zincoprım applied to surface of the luminarie before elektrostatik powder coating With LED driver

GM454L15

POWER LED

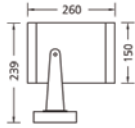

IP 65



Led Tipi Led Type	Renk Isısı Color Temperature	Toplam Güç Total Power	Akım Current	Voltaj Voltage	Toplam Lümen Total Lumen
Power LED	3000K	45W	700mA	220V AC	3687lm
Power LED	4000K	45W	700mA	220V AC	4140lm
Power LED	6500K	45W	700mA	220V AC	4630lm

Malzeme : Alüminyum enjeksiyon gövde ve ısıya dayanıklı cam

Renk : Füme, Metalik Gri, Siyah

Armatürün yüzeyine elektrostatik toz boyadan önce korozyon direncini artırıcı zincoprım uygulanır
LED sürücüsü dahil

Material : Die-cast aluminium body and tempered glass

Color : Graphite, Metalik Grey, Black

For corrosion resistance, zincoprım applied to surface of the luminarie before elektrostatik powder coating With LED driver

GM454L16

POWER LED

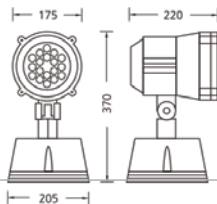

IP 65





Led Tipi Led Type	Renk Isısı Color Temperature	Toplam Güç Total Power	Akım Current	Voltaj Voltage	Toplam Lümen Total Lumen
SMD LED	3000K	0.7W	20mA	220V AC	34lm
SMD LED	5000K	0.7W	20mA	220V AC	42lm

Malzeme : Plastik enjeksiyon gövde ve paslanmaz çelik ön kapak ve plastik enjeksiyon gövde, ısıya dayanıklı cam, galvanizli metal ankastre montaj kasası

Renk : Mat Çelik
Armatürün yüzeyine elektrostatik toz boyadan önce korozyon direncini arttırıcı zincoprım uygulanır LED sürücüsü dahil

Material : Plastik injection body and stainless-steel front frame, tempered glass, galvanized pressed steel recessed box

Color : Matt Steel
For corrosion resistance, zincoprım applied to surface of the luminarie before elektrostatik powder coating With LED driver

GM405L01

SMD LED

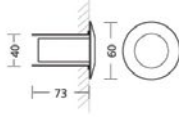

9MNK15

Ankastre Montaj Kasası / Recessed Box



IP 67

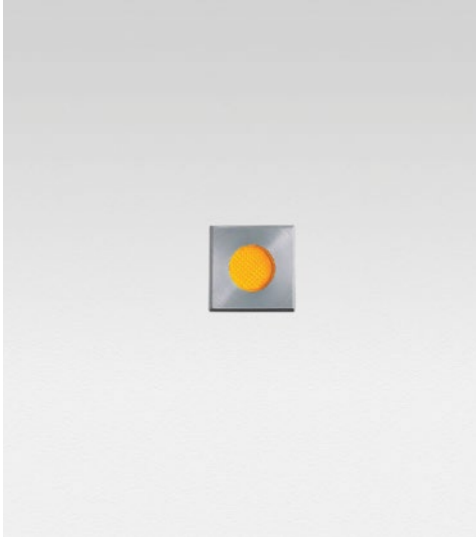

Led Tipi Led Type	Renk Isısı Color Temperature	Toplam Güç Total Power	Akım Current	Voltaj Voltage	Toplam Lümen Total Lumen
SMD LED	3000K	0.7W	20mA	220V AC	34lm
SMD LED	5000K	0.7W	20mA	220V AC	42lm

Malzeme : Plastik enjeksiyon gövde ve paslanmaz çelik ön kapak ve plastik enjeksiyon gövde, ısıya dayanıklı cam, galvanizli metal ankastre montaj kasası

Renk : Mat Çelik
Armatürün yüzeyine elektrostatik toz boyadan önce korozyon direncini arttırıcı zincoprım uygulanır LED sürücüsü dahil

Material : Plastik injection body and stainless-steel front frame, tempered glass, galvanized pressed steel recessed box

Color : Matt Steel
For corrosion resistance, zincoprım applied to surface of the luminarie before elektrostatik powder coating With LED driver

GM405L02

SMD LED

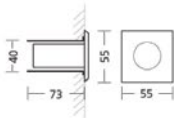

9MNK15

Ankastre Montaj Kasası / Recessed Box



IP 67





Led Tipi Led Type	Renk Isısı Color Temperature	Toplam Güç Total Power	Akım Current	Voltaj Voltage	Toplam Lümen Total Lumen
Middle Power LED	3000K	11W	116mA	220V AC	953lm
Middle Power LED	4000K	11W	116mA	220V AC	1044lm

Malzeme : Paslanmaz çelik ön çerçeve ve plastik enjeksiyon gövde, asimetrik alüminyum reflektör, ısıya dayanıklı cam, galvanizli metal ankastre montaj kasası

Renk : Füme, Metalik Gri, Siyah
Armatürün yüzeyine elektrostatik toz boyadan önce korozyon direncini artırıcı zincoprım uygulanır LED sürücüsü dahil

Material : Stainless-steel front frame and plastic injection body, tempered glass, galvanized pressed steel recessed box

Color : Graphite, Metallic Grey, Black
For corrosion resistance, zincoprım applied to surface of the luminarie before elektrostatik powder coating With LED driver

GM405L06

MIDDLE POWER LED

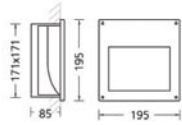
9MNK04

Ankastre Montaj Kasası / Recessed Box



IP 65



Led Tipi Led Type	Renk Isısı Color Temperature	Toplam Güç Total Power	Akım Current	Voltaj Voltage	Toplam Lümen Total Lumen
Power LED	3000K	5W	500mA	220V AC	474lm
Power LED	4000K	5W	500mA	220V AC	529lm
Power LED	6500K	5W	500mA	220V AC	596lm

Malzeme : Alüminyum enjeksiyon gövde ve akrilik difüzör, galvanizli metal ankastre montaj kasası

Renk : Füme, Metalik Gri, Siyah
Armatürün yüzeyine elektrostatik toz boyadan önce korozyon direncini artırıcı zincoprım uygulanır LED sürücüsü dahil

Material : Die-cast aluminium body and acrylic diffuser, galvanized pressed steel recessed box

Color : Graphite, Metallic Grey, Black
For corrosion resistance, zincoprım applied to surface of the luminarie before elektrostatik powder coating With LED driver

GM405L04

POWER LED

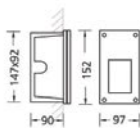
9MNK02

Ankastre Montaj Kasası / Recessed Box



IP 65





Led Tipi Led Type	Renk Isısı Color Temperature	Toplam Güç Total Power	Akım Current	Voltaj Voltage	Toplam Lümen Total Lumen
Middle Power LED	3000K	11W	116mA	220V AC	953lm
Middle Power LED	4000K	11W	116mA	220V AC	1044lm

Malzeme : Alüminyum profil ve enjeksiyon gövde, ısıya dayanıklı cam, galvanizli metal ankastre montaj kasası

Renk : Füme, Metalik Gri, Siyah
Armatürün yüzeyine elektrostatik toz boyadan önce korozyon direncini artırıcı zincoprım uygulanır LED sürücüsü dahil

Material : Die-cast aluminium and extruded body, tempered glass, galvanized pressed steel recessed box

Color : Graphite, Metallic Grey, Black
For corrosion resistance, zincoprım applied to surface of the luminarie before elektrostatik powder coating With LED driver

GM405L07

MIDDLE POWER LED

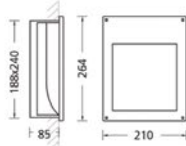

9MNK05

Ankastre Montaj Kasası / Recessed Box



IP 65



Led Tipi Led Type	Renk Isısı Color Temperature	Toplam Güç Total Power	Akım Current	Voltaj Voltage	Toplam Lümen Total Lumen
Power LED	3000K	15W	500mA	220V AC	1422lm
Power LED	4000K	15W	500mA	220V AC	1587lm
Power LED	6500K	15W	500mA	220V AC	1788lm

Malzeme : Alüminyum enjeksiyon gövde ve akrilik difüzör, galvanizli metal ankastre montaj kasası

Renk : Füme, Metalik Gri, Siyah
Armatürün yüzeyine elektrostatik toz boyadan önce korozyon direncini artırıcı zincoprım uygulanır LED sürücüsü dahil

Material : Die-cast aluminium body and acrylic diffuser, galvanized pressed steel recessed box

Color : Graphite, Metallic Grey, Black
For corrosion resistance, zincoprım applied to surface of the luminarie before elektrostatik powder coating With LED driver

GM405L10

POWER LED

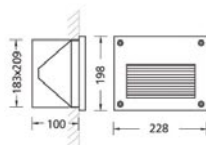

9MNK34

Ankastre Montaj Kasası / Recessed Box



IP 65





Led Tipi Led Type	Renk Isısı Color Temperature	Toplam Güç Total Power	Akım Current	Voltaj Voltage	Toplam Lümen Total Lumen
Power LED	3000K	2W	350mA	220V AC	234lm
Power LED	4000K	2W	350mA	220V AC	272lm
Power LED	6500K	2W	350mA	220V AC	294lm

Malzeme : Alüminyum enjeksiyon gövde ve akrilik difüzör, galvanizli metal ankastre montaj kasası
Renk : Füme, Metalik Gri, Siyah
 Armatürün yüzeyine elektrostatik toz boyadan önce korozyon direncini artırıcı zincoprım uygulanır LED sürücüsü dahil

Material : Die-cast aluminium body and acrylic diffuser, galvanized pressed steel recessed box
Color : Graphite, Metallic Grey, Black
 For corrosion resistance, zincoprım applied to surface of the luminarie before elektrostatik powder coating With LED driver

GM405L08

POWER LED

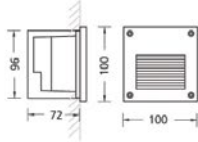

9MNK33

Ankastre Montaj Kasası / Recessed Box



IP 65



Led Tipi Led Type	Renk Isısı Color Temperature	Toplam Güç Total Power	Akım Current	Voltaj Voltage	Toplam Lümen Total Lumen
Middle Power LED	3000K	4W	116mA	220V AC	305lm
Middle Power LED	4000K	4W	116mA	220V AC	365lm

Malzeme : Alüminyum enjeksiyon gövde ve akrilik difüzör, galvanizli metal ankastre montaj kasası
Renk : Füme, Metalik Gri, Siyah
 Armatürün yüzeyine elektrostatik toz boyadan önce korozyon direncini artırıcı zincoprım uygulanır LED sürücüsü dahil

Material : Die-cast aluminium body and acrylic diffuser, galvanized pressed steel recessed box
Color : Graphite, Metallic Grey, Black
 For corrosion resistance, zincoprım applied to surface of the luminarie before elektrostatik powder coating With LED driver

GM405L09

MIDDLE POWER LED

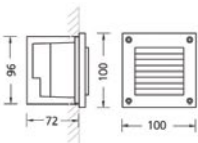

9MNK33

Ankastre Montaj Kasası / Recessed Box



IP 65





Led Tipi Led Type	Renk Isısı Color Temperature	Toplam Güç Total Power	Akım Current	Voltaj Voltage	Toplam Lümen Total Lumen
Power LED	3000K	5W	500mA	220V AC	474lm
Power LED	4000K	5W	500mA	220V AC	529lm
Power LED	6500K	5W	500mA	220V AC	596lm

Malzeme : Alüminyum enjeksiyon gövde, ısıya ve basınca dayanıklı 8mm. cam ve termoplastik anakstre montaj kasası

Renk : Füme, Metalik Gri, Siyah

Armatürün yüzeyine elektrostatik toz boyadan önce korozyon direncini artırıcı zincoprim uygulanır LED sürücüsü dahil

Material : Die-cast aluminium body, toughened glass with 8mm. and thermoplastic recessed box

Color : Graphite, Metallic Grey, Black

For corrosion resistance, zincoprim applied to surface of the luminarie before electrostatik powder coating With LED driver

GM451L05

POWER LED

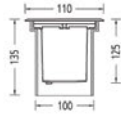

9MNK17

Anakstre Montaj Kasası / Recessed Box



IP 67



Led Tipi Led Type	Renk Isısı Color Temperature	Toplam Güç Total Power	Akım Current	Voltaj Voltage	Toplam Lümen Total Lumen
Power LED	3000K	5W	500mA	220V AC	474lm
Power LED	4000K	5W	500mA	220V AC	529lm
Power LED	6500K	5W	500mA	220V AC	596lm

Malzeme : Alüminyum enjeksiyon gövde, ısıya ve basınca dayanıklı 8mm. cam ve termoplastik anakstre montaj kasası

Renk : Füme, Metalik Gri, Siyah

Armatürün yüzeyine elektrostatik toz boyadan önce korozyon direncini artırıcı zincoprim uygulanır LED sürücüsü dahil

Material : Die-cast aluminium body, toughened glass with 8mm. and thermoplastic recessed box

Color : Graphite, Metallic Grey, Black

For corrosion resistance, zincoprim applied to surface of the luminarie before electrostatik powder coating With LED driver

GM451L06

POWER LED

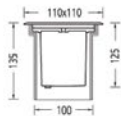

9MNK18

Anakstre Montaj Kasası / Recessed Box



IP 67





Led Tipi Led Type	Renk Isısı Color Temperature	Toplam Güç Total Power	Akım Current	Voltaj Voltage	Toplam Lümen Total Lumen
Power LED	3000K	5W	500mA	220V AC	474lm
Power LED	4000K	5W	500mA	220V AC	529lm
Power LED	6500K	5W	500mA	220V AC	596lm

Malzeme : Alüminyum enjeksiyon gövde ve paslanmaz çelik ön kapak, ısıya ve basınca dayanıklı 8mm. cam ve termoplastik ankastre montaj kasası

Renk : Mat Çelik
Armatürün yüzeyine elektrostatik toz boyadan önce korozyon direncini artırıcı zincoprım uygulanır LED sürücüsü dahil

Material : Die-cast aluminium body and stainless-steel front frame, toughened glass with 8mm. and thermoplastic recessed box

Color : Matt Steel
For corrosion resistance, zincoprım applied to surface of the luminarie before elektrostatik powder coating With LED driver

GM451L07

POWER LED

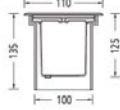
9MNK17

Ankastre Montaj Kasası / Recessed Box



IP 67

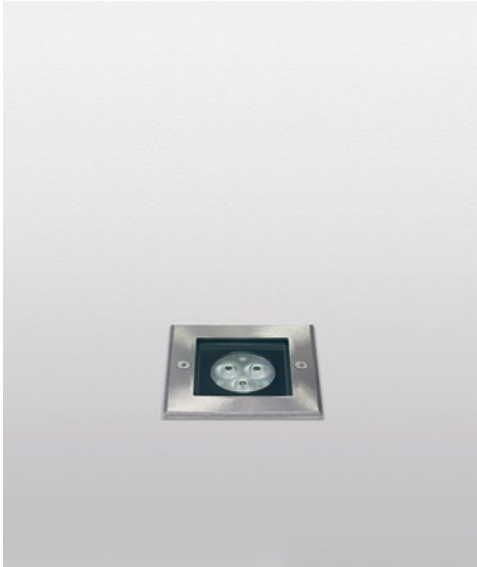

Led Tipi Led Type	Renk Isısı Color Temperature	Toplam Güç Total Power	Akım Current	Voltaj Voltage	Toplam Lümen Total Lumen
Power LED	3000K	5W	500mA	220V AC	474lm
Power LED	4000K	5W	500mA	220V AC	529lm
Power LED	6500K	5W	500mA	220V AC	596lm

Malzeme : Alüminyum enjeksiyon gövde, ısıya ve basınca dayanıklı 8mm. cam ve termoplastik ankastre montaj kasası

Renk : Mat Çelik
Armatürün yüzeyine elektrostatik toz boyadan önce korozyon direncini artırıcı zincoprım uygulanır LED sürücüsü dahil

Material : Die-cast aluminium body, toughened glass with 8mm. and thermoplastic recessed box

Color : Matt Steel
For corrosion resistance, zincoprım applied to surface of the luminarie before elektrostatik powder coating With LED driver

GM451L08

POWER LED

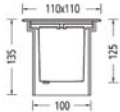
9MNK18

Ankastre Montaj Kasası / Recessed Box



IP 67





Led Tipi Led Type	Renk Isısı Color Temperature	Toplam Güç Total Power	Akım Current	Voltaj Voltage	Toplam Lümen Total Lumen
Power LED	3000K	5W	500mA	220V AC	474lm
Power LED	4000K	5W	500mA	220V AC	529lm
Power LED	6500K	5W	500mA	220V AC	596lm

Malzeme : Alüminyum enjeksiyon gövde, ısıya ve basınca dayanıklı 8mm. cam ve termoplastik ankastre montaj kasası

Renk : Mat Çelik
Armatürün yüzeyine elektrostatik toz boyadan önce korozyon direncini artırıcı zincoprım uygulanır LED sürücüsü dahil

Material : Die-cast aluminium body, toughened glass with 8mm. and thermoplastic recessed box

Color : Matt Steel
For corrosion resistance, zincoprım applied to surface of the luminarie before elektrostatik powder coating With LED driver

GM451L09

POWER LED

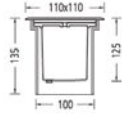

9MNK17

Ankastre Montaj Kasası / Recessed Box



IP 67



Led Tipi Led Type	Renk Isısı Color Temperature	Toplam Güç Total Power	Akım Current	Voltaj Voltage	Toplam Lümen Total Lumen
Power LED	3000K	10W	500mA	220V AC	948lm
Power LED	4000K	10W	500mA	220V AC	1058lm
Power LED	6500K	10W	500mA	220V AC	1192lm

Malzeme : Alüminyum enjeksiyon gövde, ısıya ve basınca dayanıklı 15mm. cam ve termoplastik ankastre montaj kasası

Renk : Füme, Metalik Gri, Siyah
Armatürün yüzeyine elektrostatik toz boyadan önce korozyon direncini artırıcı zincoprım uygulanır LED sürücüsü dahil

Material : Die-cast aluminium body, toughened glass with 15mm. and thermoplastic recessed box

Color : Graphite, Metallic Grey, Black
For corrosion resistance, zincoprım applied to surface of the luminarie before elektrostatik powder coating With LED driver

GM451L10

POWER LED

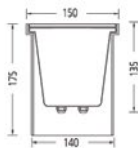

9MNK19

Ankastre Montaj Kasası / Recessed Box



IP 67





Led Tipi Led Type	Renk Isısı Color Temperature	Toplam Güç Total Power	Akım Current	Voltaj Voltage	Toplam Lümen Total Lumen
Power LED	3000K	10W	500mA	220V AC	948lm
Power LED	4000K	10W	500mA	220V AC	1058lm
Power LED	6500K	10W	500mA	220V AC	1192lm

Malzeme : Alüminyum enjeksiyon gövde, ısıya ve basınca dayanıklı 15mm. cam ve termoplastik ankastre montaj kasası

Renk : Füme, Metalik Gri, Siyah

Armatürün yüzeyine elektrostatik toz boyadan önce korozyon direncini artırıcı zincoprım uygulanır LED sürücüsü dahil

Material : Die-cast aluminium body, toughened glass with 15mm. and thermoplastic recessed box

Color : Graphite, Metallic Grey, Black

For corrosion resistance, zincoprım applied to surface of the luminarie before elektrostatik powder coating With LED driver

GM451L20

POWER LED

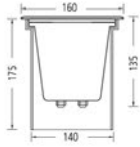
9MNK19

Ankastre Montaj Kasası / Recessed Box



IP 67



Led Tipi Led Type	Renk Isısı Color Temperature	Toplam Güç Total Power	Akım Current	Voltaj Voltage	Toplam Lümen Total Lumen
Power LED	3000K	15W	500mA	220V AC	1422lm
Power LED	4000K	15W	500mA	220V AC	1587lm
Power LED	6500K	15W	500mA	220V AC	1788lm

Malzeme : Alüminyum enjeksiyon gövde, ısıya ve basınca dayanıklı 15mm. cam ve termoplastik ankastre montaj kasası

Renk : Füme, Metalik Gri, Siyah

Armatürün yüzeyine elektrostatik toz boyadan önce korozyon direncini artırıcı zincoprım uygulanır LED sürücüsü dahil

Material : Die-cast aluminium body, toughened glass with 15mm. and thermoplastic recessed box

Color : Graphite, Metallic Grey, Black

For corrosion resistance, zincoprım applied to surface of the luminarie before elektrostatik powder coating With LED driver

GM451L11

POWER LED

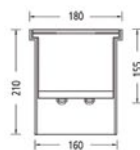
9MNK26

Ankastre Montaj Kasası / Recessed Box



IP 67





Led Tipi Led Type	Renk Isısı Color Temperature	Toplam Güç Total Power	Akım Current	Voltaj Voltage	Toplam Lümen Total Lumen
Power LED	3000K	15W	500mA	220V AC	1422lm
Power LED	4000K	15W	500mA	220V AC	1587lm
Power LED	6500K	15W	500mA	220V AC	1788lm

Malzeme : Alüminyum enjeksiyon gövde ve paslanmaz çelik ön kapak, ısıya ve basınca dayanıklı 15mm. cam ve termoplastik ankastre montaj kasası

Renk : Mat Çelik

Armatürün yüzeyine elektrostatik toz boyadan önce korozyon direncini artırıcı zincoprım uygulanır LED sürücüsü dahil

Material : Die-cast aluminium body and stainless-steel front frame, toughened glass with 15mm. and thermoplastic recessed box

Color : Matt Steel

For corrosion resistance, zincoprım applied to surface of the luminarie before elektrostatik powder coating With LED driver

GM451L12

POWER LED

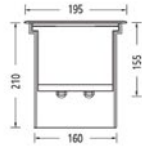

9MNK26

Ankastre Montaj Kasası / Recessed Box



IP 67



Led Tipi Led Type	Renk Isısı Color Temperature	Toplam Güç Total Power	Akım Current	Voltaj Voltage	Toplam Lümen Total Lumen
Power LED	3000K	15W	500mA	220V AC	1422lm
Power LED	4000K	15W	500mA	220V AC	1587lm
Power LED	6500K	15W	500mA	220V AC	1788lm

Malzeme : Alüminyum enjeksiyon gövde, ısıya ve basınca dayanıklı 15mm. cam ve termoplastik ankastre montaj kasası

Renk : Mat Çelik

Armatürün yüzeyine elektrostatik toz boyadan önce korozyon direncini artırıcı zincoprım uygulanır LED sürücüsü dahil

Material : Die-cast aluminium body, toughened glass with 15mm. and thermoplastic recessed box

Color : Matt Steel

For corrosion resistance, zincoprım applied to surface of the luminarie before elektrostatik powder coating With LED driver

GM451L13

POWER LED

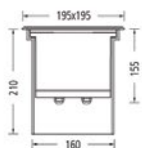

9MNK26

Ankastre Montaj Kasası / Recessed Box



IP 67





Led Tipi Led Type	Renk Isısı Color Temperature	Toplam Güç Total Power	Akım Current	Voltaj Voltage	Toplam Lümen Total Lumen
Power LED	3000K	34W	700mA	220V AC	2880lm
Power LED	4000K	34W	700mA	220V AC	3648lm
Power LED	6500K	34W	700mA	220V AC	3960lm

Malzeme : Alüminyum enjeksiyon gövde ve paslanmaz çelik ön kapak, ısıya ve basınca dayanıklı 15mm. cam ve termoplastik ankastre montaj kasası

Renk : Mat Çelik
Armatürün yüzeyine elektrostatik toz boyadan önce korozyon direncini artırıcı zincoprım uygulanır LED sürücüsü dahil

Material : Die-cast aluminium body and stainless-steel front frame, toughened glass with 15mm. and thermoplastic recessed box

Color : Matt Steel
For corrosion resistance, zincoprım applied to surface of the luminarie before elektrostatik powder coating With LED driver

GM451L15

POWER LED

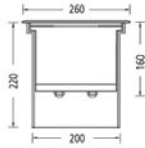
9MNK27

Ankastre Montaj Kasası / Recessed Box



IP 67



Wallwasher

Malzeme : Alüminyum enjeksiyon gövde ve paslanmaz çelik ön kapak, ısıya ve basınca dayanıklı 15mm. cam ve termoplastik ankastre montaj kasası

Renk : Mat Çelik
Armatürün yüzeyine elektrostatik toz boyadan önce korozyon direncini artırıcı zincoprım uygulanır LED sürücüsü dahil

Material : Die-cast aluminium body and stainless-steel front frame, toughened glass with 15mm. and thermoplastic recessed box

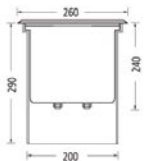
Color : Matt Steel
For corrosion resistance, zincoprım applied to surface of the luminarie before elektrostatik powder coating With LED driver

GM851114

9MNK21

Ankastre Montaj Kasası / Recessed Box



IP 67





Led Tipi Led Type	Renk Isısı Color Temperature	Toplam Güç Total Power	Akım Current	Voltaj Voltage	Toplam Lümen Total Lumen
Power LED	3000K	20W	500mA	220V AC	1896lm
Power LED	4000K	20W	500mA	220V AC	2116lm
Power LED	6500K	20W	500mA	220V AC	2384lm

Malzeme : Alüminyum enjeksiyon gövde, ısıya ve basınca dayanıklı 15mm. cam ve termoplastik ankastre montaj kasası

Renk : Füme, Metalik Gri, Siyah

Armatürün yüzeyine elektrostatik toz boyadan önce korozyon direncini artırıcı zincoprım uygulanır LED sürücüsü dahil

Material : Die-cast aluminium body, toughened glass with 15mm. and thermoplastic recessed box

Color : Graphite, Metallic Grey, Black

For corrosion resistance, zincoprım applied to surface of the luminarie before elektrostatik powder coating With LED driver

GM451L14

POWER LED

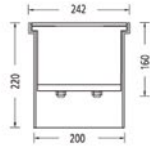

9MNK27

Ankastre Montaj Kasası / Recessed Box



IP 67



Led Tipi Led Type	Renk Isısı Color Temperature	Toplam Güç Total Power	Akım Current	Voltaj Voltage	Toplam Lümen Total Lumen
Power LED	3000K	20W	500mA	220V AC	1896lm
Power LED	4000K	20W	500mA	220V AC	2116lm
Power LED	6500K	20W	500mA	220V AC	2384lm

Malzeme : Alüminyum enjeksiyon gövde ve paslanmaz çelik ön kapak, ısıya ve basınca dayanıklı 15mm. cam ve termoplastik ankastre montaj kasası

Renk : Mat Çelik

Armatürün yüzeyine elektrostatik toz boyadan önce korozyon direncini artırıcı zincoprım uygulanır LED sürücüsü dahil

Material : Die-cast aluminium body and stainless-steel front frame, toughened glass with 15mm. and thermoplastic recessed box

Color : Matt Steel

For corrosion resistance, zincoprım applied to surface of the luminarie before elektrostatik powder coating With LED driver

GM451L25

POWER LED

GM451L26

RGB POWER LED

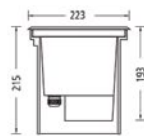

9MNK30

Ankastre Montaj Kasası / Recessed Box



IP 67





Led Tipi Led Type	Renk Isısı Color Temperature	Toplam Güç Total Power	Akım Current	Voltaj Voltage	Toplam Lümen Total Lumen
Power LED	3000K	1.5W	350mA	220V AC	175lm
Power LED	4000K	1.5W	350mA	220V AC	204lm
Power LED	6500K	1.5W	350mA	220V AC	220lm

Malzeme : Alüminyum profil gövde, paslanmaz çelik ön kapak, ısıya dayanıklı cam ve ankastre montaj kasası

Renk : Mat Çelik

Armatürün yüzeyine elektrostatik toz boyadan önce korozyon direncini artırıcı zincoprım uygulanır LED sürücüsü dahil

Material : Extruded aluminium body, stainless-steel front frame, tempered glass and aluminium recessed box

Color : Matt Steel

For corrosion resistance, zincoprım applied to surface of the luminarie before elektrostatik powder coating With LED driver

GM451L29

POWER LED

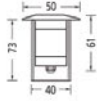

9MNK15

Ankastre Montaj Kasası / Recessed Box



IP 67



Led Tipi Led Type	Renk Isısı Color Temperature	Toplam Güç Total Power	Akım Current	Voltaj Voltage	Toplam Lümen Total Lumen
Power LED	3000K	3W	700mA	220V AC	351lm
Power LED	4000K	3W	700mA	220V AC	408lm
Power LED	6500K	3W	700mA	220V AC	441lm

Malzeme : Alüminyum profil gövde, paslanmaz çelik ön kapak, ısıya dayanıklı cam ve ankastre montaj kasası

Renk : Mat Çelik

Armatürün yüzeyine elektrostatik toz boyadan önce korozyon direncini artırıcı zincoprım uygulanır LED sürücüsü dahil

Material : Extruded aluminium body, stainless-steel front frame, tempered glass and aluminium recessed box

Color : Matt Steel

For corrosion resistance, zincoprım applied to surface of the luminarie before elektrostatik powder coating With LED driver

GM451L28

POWER LED

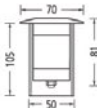

9MNK36

Ankastre Montaj Kasası / Recessed Box



IP 67



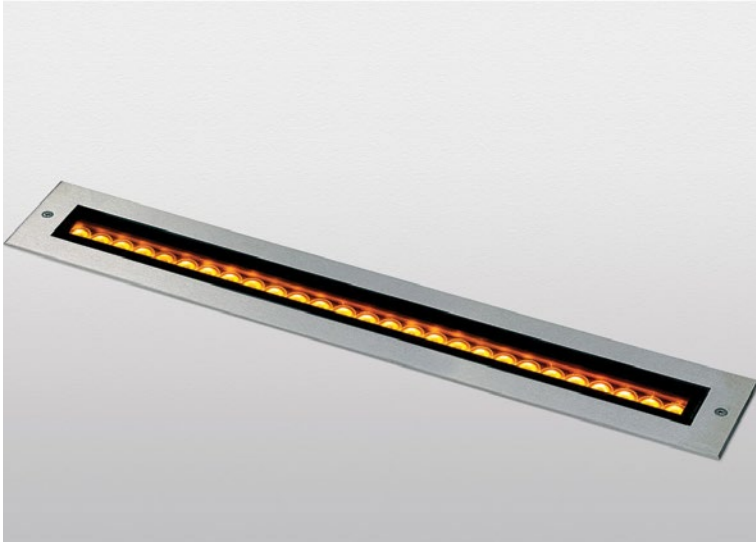

Malzeme : Alüminyum profil ve enjeksiyon gövde, paslanmaz çelik ön kapak, ısıya dayanıklı cam ve ankastre montaj kasası
Renk : Mat Çelik
 Armatürün yüzeyine elektrostatik toz boyadan önce korozyon direncini arttırıcı zincoprım uygulanır
 LED sürücüsü dahil



Material : Extruded aluminium and injection body, stainless-steel front frame, tempered glass and aluminium recessed box



Color : Matt Steel
 For corrosion resistance, zincoprım applied to surface of the luminarie before elektrostatik powder coating
 With LED driver



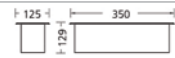



IP 67



GM451L01	9MNK22		Led Tipi Led Type	Renk Isısı Color Temperature	Toplam Güç Total Power	Akım Current	Voltaj Voltage	Toplam Lümen Total Lumen
9 X POWER LED			Power LED	3000K	10W	350mA	220V AC	1053lm
			Power LED	4000K	10W	350mA	220V AC	1134lm
			Power LED	6500K	10W	350mA	220V AC	1323lm

GM451L02	9MNK23		Led Tipi Led Type	Renk Isısı Color Temperature	Toplam Güç Total Power	Akım Current	Voltaj Voltage	Toplam Lümen Total Lumen
18 X POWER LED			Power LED	3000K	21W	350mA	220V AC	2106lm
			Power LED	4000K	21W	350mA	220V AC	2268lm
			Power LED	6500K	21W	350mA	220V AC	2646lm

GM451L03	9MNK24		Led Tipi Led Type	Renk Isısı Color Temperature	Toplam Güç Total Power	Akım Current	Voltaj Voltage	Toplam Lümen Total Lumen
27 X POWER LED			Power LED	3000K	32W	350mA	220V AC	3159lm
			Power LED	4000K	32W	350mA	220V AC	3402lm
			Power LED	6500K	32W	350mA	220V AC	3969lm

GM451L04	9MNK25		Led Tipi Led Type	Renk Isısı Color Temperature	Toplam Güç Total Power	Akım Current	Voltaj Voltage	Toplam Lümen Total Lumen
36 X POWER LED			Power LED	3000K	42W	350mA	220V AC	4212lm
			Power LED	4000K	42W	350mA	220V AC	4536lm
			Power LED	6500K	42W	350mA	220V AC	5292lm

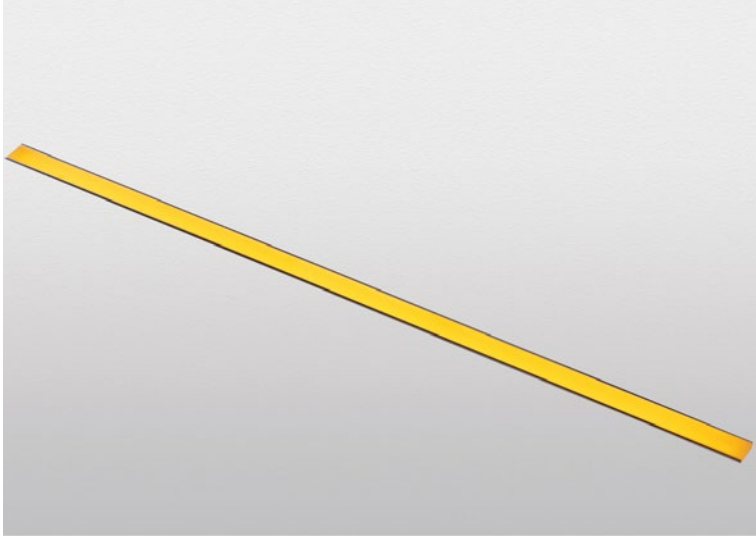

Malzeme : Dudaksız alüminyum profil ve enjeksiyon gövde, polimer kaplama
Renk : Füme, Metalik Gri, Siyah
 Armatürün yüzeyine elektrostatik toz boyadan önce korozyon direncini artırıcı zincoprım uygulanır LED trafosu ile kullanılmalı
Material : Trimless aluminium profile and injection body, polymer covering
Color : Graphite, Metallic Grey, Black
 For corrosion resistance, zincoprım applied to surface of the luminarie before electrostatik powder coating With LED transformers



IP 67



Model	POWER LED	Technical Drawing	Led Tipi Led Type	Renk Isısı Color Temperature	Toplam Güç Total Power	Akım Current	Voltaj Voltage	Toplam Lümen Total Lumen
GM451L31	POWER LED		Power LED	3000K	3.4W	116mA	24V DC	216lm
			Power LED	4000K	3.4W	116mA	24V DC	235lm
			Power LED	6500K	3.4W	116mA	24V DC	291lm
GM451L32	POWER LED		Power LED	3000K	4.5W	116mA	24V DC	288lm
			Power LED	4000K	4.5W	116mA	24V DC	319lm
			Power LED	6500K	4.5W	116mA	24V DC	363lm
GM451L33	POWER LED		Power LED	3000K	6.7W	116mA	24V DC	432lm
			Power LED	4000K	6.7W	116mA	24V DC	465lm
			Power LED	6500K	6.7W	116mA	24V DC	511lm
GM451L34	POWER LED		Power LED	3000K	8.9W	116mA	24V DC	576lm
			Power LED	4000K	8.9W	116mA	24V DC	634lm
			Power LED	6500K	8.9W	116mA	24V DC	687lm
GM451L35	POWER LED		Power LED	3000K	10W	116mA	24V DC	648lm
			Power LED	4000K	10W	116mA	24V DC	693lm
			Power LED	6500K	10W	116mA	24V DC	735lm
GM451L36	POWER LED		Power LED	3000K	13.3W	116mA	24V DC	864lm
			Power LED	4000K	13.3W	116mA	24V DC	927lm
			Power LED	6500K	13.3W	116mA	24V DC	979lm



MYSIA

Led Tipi Led Type	Renk Isısı Color Temperature	Toplam Güç Total Power	Akım Current	Voltaj Voltage	Toplam Lümen Total Lumen
Middle Power LED	3000K	22W	116mA	220V AC	1905lm
Middle Power LED	4000K	22W	116mA	220V AC	2087lm

Malzeme : Alüminyum profil ve enjeksiyon gövde, alüminyum reflektör ve polikarbonat difüzör, galvanizli metal ankraj

Renk : Füme, Metalik Gri, Siyah

Armatürün yüzeyine elektrostatik toz boyadan önce korozyon direncini artırıcı zincoprım uygulanır LED sürücüsü dahil

Material : Die-cast aluminium and extruded body, aluminium reflector polycarbonate diffuser, galvanized metal anchorage

Color : Graphite, Metalik Grey, Black

For corrosion resistance, zincoprım applied to surface of the luminarie before elektrostatik powder coating With LED driver

GM054L01

MIDDLE POWER LED

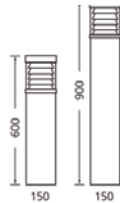

9ANK03

Ankraj / Anchorage



IP 65





PAPULUS

Led Tipi Led Type	Renk Isısı Color Temperature	Toplam Güç Total Power	Akım Current	Voltaj Voltage	Toplam Lümen Total Lumen
Middle Power LED	3000K	22W	116mA	220V AC	1905lm
Middle Power LED	4000K	22W	116mA	220V AC	2087lm

Malzeme : Alüminyum profil ve enjeksiyon gövde, alüminyum reflektör ve polikarbonat difüzör, galvanizli metal ankraj

Renk : Füme, Metalik Gri, Siyah
Armatürün yüzeyine elektrostatik toz boyadan önce korozyon direncini artırıcı zincoprım uygulanır LED sürücüsü dahil

Material : Die-cast aluminium and extruded body, aluminium reflector polycarbonate diffuser, galvanized metal anchorage

Color : Graphite, Metalik Grey, Black
For corrosion resistance, zincoprım applied to surface of the luminarie before elektrostatik powder coating With LED driver

GM054L03

MIDDLE POWER LED



9ANK12

Ankraj / Anchorage

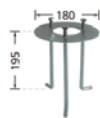

IP 65





MELIA

Led Tipi Led Type	Renk Isısı Color Temperature	Toplam Güç Total Power	Akım Current	Voltaj Voltage	Toplam Lümen Total Lumen
Middle Power LED	3000K	22W	116mA	220V AC	1905lm
Middle Power LED	4000K	22W	116mA	220V AC	2087lm

Malzeme : Alüminyum profil ve enjeksiyon gövde, alüminyum reflektör ve polikarbonat difüzör, galvanizli metal ankraj

Renk : Füme, Metalik Gri, Siyah

Armatürün yüzeyine elektrostatik toz boyadan önce korozyon direncini artırıcı zincoprım uygulanır LED sürücüsü dahil

Material : Die-cast aluminium and extruded body, aluminium reflector polycarbonate diffuser, galvanized metal anchorage

Color : Graphite, Metalik Grey, Black

For corrosion resistance, zincoprım applied to surface of the luminarie before elektrostatik powder coating With LED driver

GM054L04

MIDDLE POWER LED



9ANK12

Ankraj / Anchorage

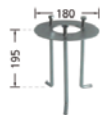

IP 65





PLATANUS

Led Tipi Led Type	Renk Isısı Color Temperature	Toplam Güç Total Power	Akım Current	Voltaj Voltage	Toplam Lümen Total Lumen
Power LED	3000K	15W	500mA	220V AC	1422lm
Power LED	4000K	15W	500mA	220V AC	1587lm
Power LED	6500K	15W	500mA	220V AC	1788lm

Malzeme : Alüminyum profil ve enjeksiyon gövde, ısıya dayanıklı cam, galvanizli metal ankraj

Renk : Füme, Metalik Gri, Siyah

Armatürün yüzeyine elektrostatik toz boyadan önce korozyon direncini artırıcı zincoprım uygulanır
LED sürücüsü dahil

Material : Die-cast aluminium and extruded body, tempered glass, galvanized metal anchorage

Color : Graphite, Metallik Grey, Black

For corrosion resistance, zincoprım applied to surface of the luminaire before elektrostatik powder coating With LED driver

GM054L05

POWER LED

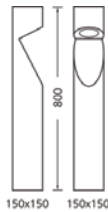

9ANK03

Ankraj / Anchorage



IP 65



MUSHROOM



Led Tipi Led Type	Renk Isısı Color Temperature	Toplam Güç Total Power	Akım Current	Voltaj Voltage	Toplam Lümen Total Lumen
Power LED	3000K	20W	500mA	220V AC	1896lm
Power LED	4000K	20W	500mA	220V AC	2116lm
Power LED	6500K	20W	500mA	220V AC	2384lm

Malzeme : Alüminyum profil ve enjeksiyon gövde, akrilik difüzör, galvanizli metal ankraj

Renk : Füme, Metalik Gri, Siyah

Armatürün yüzeyine elektrostatik toz boyadan önce korozyon direncini arttırıcı zincoprım uygulanır
LED sürücüsü dahil

Material : Die-cast aluminium and extruded body, acrylic diffuser, galvanized metal anchorage

Color : Graphite, Metallik Grey, Black

For corrosion resistance, zincoprım applied to surface of the luminaire before elektrostatik powder coating With LED driver

GM054L06

POWER LED



9ANK03

Ankraj / Anchorage



IP 65



LARIX



Led Tipi Led Type	Renk Isısı Color Temperature	Toplam Güç Total Power	Akım Current	Voltaj Voltage	Toplam Lümen Total Lumen
Power LED	3000K	12W	500mA	220V AC	1138lm
Power LED	4000K	12W	500mA	220V AC	1270lm
Power LED	6500K	12W	500mA	220V AC	1430lm

Malzeme : Alüminyum profil ve enjeksiyon gövde, ısıya dayanıklı cam, galvanizli metal ankraj

Renk : Füme, Metalik Gri, Siyah

Armatürün yüzeyine elektrostatik toz boyadan önce korozyon direncini artırıcı zincoprime uygulanır
LED sürücüsü dahil

Material : Die-cast aluminium and extruded body, tempered glass, galvanized metal anchorage

Color : Graphite, Metallik Grey, Black

For corrosion resistance, zincoprime applied to surface of the luminaire before electrostatik powder coating With LED driver

GM054L07

POWER LED

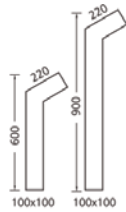

9ANK02

Ankraj / Anchorage



IP 65





GINEPRO

Led Tipi Led Type	Renk Isısı Color Temperature	Toplam Güç Total Power	Akım Current	Voltaj Voltage	Toplam Lümen Total Lumen
COB LED	3000K	10W	500mA	220V AC	940lm
COB LED	4000K	10W	500mA	220V AC	995lm
COB LED	6500K	10W	500mA	220V AC	1085lm

Malzeme : Alüminyum profil ve enjeksiyon gövde, ısıya dayanıklı cam, galvanizli metal ankraj

Renk : Füme, Metalik Gri, Siyah

Armatürün yüzeyine elektrostatik toz boyadan önce korozyon direncini arttırıcı zincoprım uygulanır
LED sürücüsü dahil

Material : Die-cast aluminium and extruded body, tempered glass, galvanized metal anchorage

Color : Graphite, Metallik Grey, Black

For corrosion resistance, zincoprım applied to surface of the luminaire before elektrostatik powder coating With LED driver

GM054L09

COB LED



9ANK02

Ankraj / Anchorage



IP 65



FAGUS

Led Tipi Led Type	Renk Isısı Color Temperature	Toplam Güç Total Power	Akım Current	Voltaj Voltage	Toplam Lümen Total Lumen
Middle Power LED	3000K	11W	116mA	220V AC	953lm
Middle Power LED	4000K	11W	116mA	220V AC	1044lm



Malzeme : Alüminyum profil ve enjeksiyon gövde, akrilik difüzör, galvanizli metal ankraj

Renk : Füme, Metalik Gri, Siyah

Armatürün yüzeyine elektrostatik toz boyadan önce korozyon direncini arttırıcı zincoprım uygulanır
LED sürücüsü dahil

Material : Die-cast aluminium and extruded body, acrylic diffuser, galvanized metal anchorage

Color : Graphite, Metallik Grey, Black

For corrosion resistance, zincoprım applied to surface of the luminaire before elektrostatik powder coating With LED driver

GM054L10

MIDDLE POWER LED

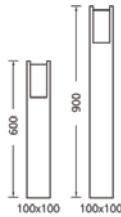

9ANK02

Ankraj / Anchorage



IP 54



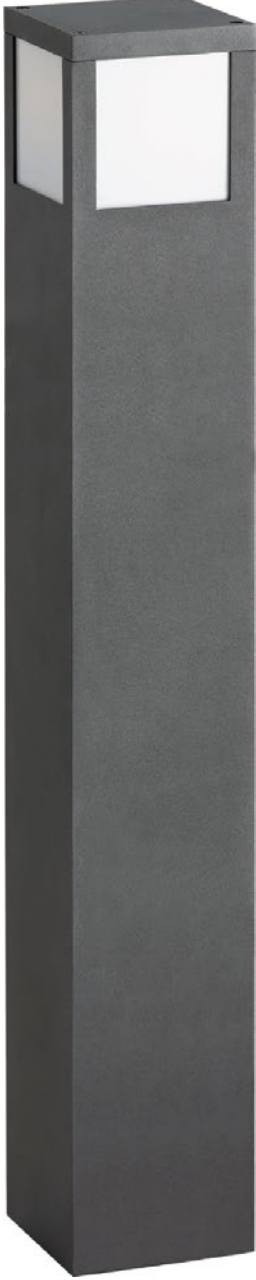

ALNUS

Led Tipi Led Type	Renk Isısı Color Temperature	Toplam Güç Total Power	Akım Current	Voltaj Voltage	Toplam Lümen Total Lumen
Power LED	3000K	20W	500mA	220V AC	1896lm
Power LED	4000K	20W	500mA	220V AC	2116lm
Power LED	6500K	20W	500mA	220V AC	2384lm

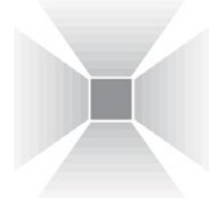

Malzeme : Alüminyum profil ve enjeksiyon gövde, akrilik difüzör, galvanizli metal ankraj

Renk : Füme, Metalik Gri, Siyah

Armatürün yüzeyine elektrostatik toz boyadan önce korozyon direncini arttırıcı zincoprım uygulanır
LED sürücüsü dahil

Material : Die-cast aluminium and extruded body, acrylic diffuser, galvanized metal anchorage

Color : Graphite, Metallik Grey, Black

For corrosion resistance, zincoprım applied to surface of the luminaire before elektrostatik
powder coating With LED driver

GM054L11

POWER LED



9ANK09

Ankraj / Anchorage



IP 65



KORINT



Led Tipi Led Type	Renk Isısı Color Temperature	Toplam Güç Total Power	Akım Current	Voltaj Voltage	Toplam Lümen Total Lumen
Middle Power LED	3000K	11W	116mA	220V AC	953lm
Middle Power LED	4000K	11W	116mA	220V AC	1044lm

Malzeme : Üst başlık alüminyum enjeksiyon ve akrilik difüzör, çelik boru direk gövdesi, galvanizli metal ankraj

Renk : Füme, Metalik Gri, Siyah
Armatürün yüzeyine elektrostatik toz boyadan önce korozyon direncini artırıcı zincoprime uygulanır LED sürücüsü dahil

Material : Die-cast aluminium and acrylic diffuser upper head, pole body made of steel tube, galvanized metal anchorage

Color : Graphite, Metalik Grey, Black
For corrosion resistance, zincoprime applied to surface of the luminarie before electrostatik powder coating With LED driver

GM054L12

MIDDLE POWER LED

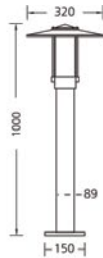

9ANK01

Ankraj / Anchorage



IP 54





FAGUS

Led Tipi Led Type	Renk Isısı Color Temperature	Toplam Güç Total Power	Akım Current	Voltaj Voltage	Toplam Lümen Total Lumen
Middle Power LED	3000K	22W	116mA	220V AC	1905lm
Middle Power LED	4000K	22W	116mA	220V AC	2087lm



Malzeme : Alüminyum profil ve enjeksiyon gövde, akrilik difüzör, galvanizli metal ankraj

Renk : Füme, Metalik Gri, Siyah

Armatürün yüzeyine elektrostatik toz boyadan önce korozyon direncini arttırıcı zincoprım uygulanır
LED sürücüsü dahil

Material : Die-cast aluminium and extruded body, acrylic diffuser, galvanized metal anchorage

Color : Graphite, Metallik Grey, Black

For corrosion resistance, zincoprım applied to surface of the luminaire before elektrostatik powder coating With LED driver

GM054L13

MIDDLE POWER LED



9ANK02

Ankraj / Anchorage



IP 54



CEDRUS



Led Tipi Led Type	Renk Isısı Color Temperature	Toplam Güç Total Power	Akım Current	Voltaj Voltage	Toplam Lümen Total Lumen
Middle Power LED	3000K	22W	116mA	220V AC	1905lm
Middle Power LED	4000K	22W	116mA	220V AC	2087lm



Malzeme : Alüminyum profil ve enjeksiyon gövde, akrilik difüzör, galvanizli metal ankraj

Renk : Füme, Metalik Gri, Siyah

Armatürün yüzeyine elektrostatik toz boyadan önce korozyon direncini artırıcı zincoprım uygulanır
LED sürücüsü dahil

Material : Die-cast aluminium and extruded body, acrylic diffuser, galvanized metal anchorage

Color : Graphite, Metalik Grey, Black

For corrosion resistance, zincoprım applied to surface of the luminarie before elektrostatik
powder coating With LED driver

GM054L14

MIDDLE POWER LED



9ANK09

Ankraj / Anchorage



IP 54



BETULA



Led Tipi Led Type	Renk Isısı Color Temperature	Toplam Güç Total Power	Akım Current	Voltaj Voltage	Toplam Lümen Total Lumen
Middle Power LED	3000K	16W	116mA	220V AC	1320lm
Middle Power LED	4000K	16W	116mA	220V AC	1460lm

Malzeme : Alüminyum profil ve enjeksiyon gövde, akrilik difüzör, galvanizli metal ankraj

Renk : Füme, Metalik Gri, Siyah

Armatürün yüzeyine elektrostatik toz boyadan önce korozyon direncini artırıcı zincoprım uygulanır
LED sürücüsü dahil

Material : Die-cast aluminium and extruded body, acrylic diffuser, galvanized metal anchorage

Color : Graphite, Metalik Grey, Black

For corrosion resistance, zincoprım applied to surface of the luminarie before elektrostatik
powder coating With LED driver

GM054L15

MIDDLE POWER LED



9ANK09

Ankraj / Anchorage



IP 65



PUNICA

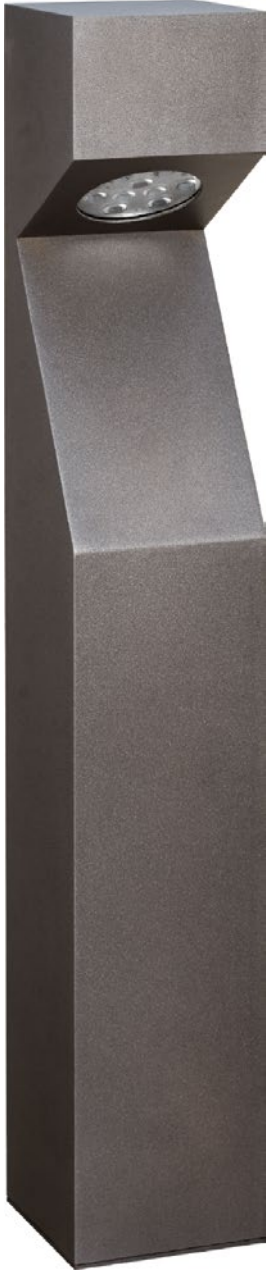

Led Tipi Led Type	Renk Isısı Color Temperature	Toplam Güç Total Power	Akım Current	Voltaj Voltage	Toplam Lümen Total Lumen
Power LED	3000K	15W	500mA	220V AC	1422lm
Power LED	4000K	15W	500mA	220V AC	1587lm
Power LED	6500K	15W	500mA	220V AC	1788lm

Malzeme : Alüminyum profil ve enjeksiyon gövde, akrilik difüzör, galvanizli metal ankraj

Renk : Füme, Metalik Gri, Siyah

Armatürün yüzeyine elektrostatik toz boyadan önce korozyon direncini artırıcı zincoprım uygulanır
LED sürücüsü dahil

Material : Die-cast aluminium and extruded body, acrylic diffuser, galvanized metal anchorage

Color : Graphite, Metallik Grey, Black

For corrosion resistance, zincoprım applied to surface of the luminarie before elektrostatik powder coating With LED driver

GM054L17

POWER LED

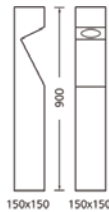

9ANK09

Ankraj / Anchorage



IP 65





CORNUS

Led Tipi Led Type	Renk Isısı Color Temperature	Toplam Güç Total Power	Akım Current	Voltaj Voltage	Toplam Lümen Total Lumen
Middle Power LED	3000K	11W	116mA	220V AC	953lm
Middle Power LED	4000K	11W	116mA	220V AC	1044lm

Malzeme : Alüminyum profil ve enjeksiyon gövde, akrilik difüzör, galvanizli metal ankraj

Renk : Füme, Metalik Gri, Siyah

Armatürün yüzeyine elektrostatik toz boyadan önce korozyon direncini artırıcı zincoprım uygulanır
LED sürücüsü dahil

Material : Die-cast aluminium and extruded body, acrylic diffuser, galvanized metal anchorage

Color : Graphite, Metalik Grey, Black

For corrosion resistance, zincoprım applied to surface of the luminarie before elektrostatik
powder coating With LED driver

GM054L18

MIDDLE POWER LED



9ANK09

Ankraj / Anchorage



IP 54





GINEPRO

Led Tipi Led Type	Renk Isısı Color Temperature	Toplam Güç Total Power	Akım Current	Voltaj Voltage	Toplam Lümen Total Lumen
COB LED	3000K	21W	500mA	220V AC	2260lm
COB LED	4000K	21W	500mA	220V AC	2456lm
COB LED	6500K	21W	500mA	220V AC	2456lm

Malzeme : Alüminyum profil ve enjeksiyon gövde, ısıya dayanıklı cam, galvanizli metal ankraj

Renk : Füme, Metalik Gri, Siyah

Armatürün yüzeyine elektrostatik toz boyadan önce korozyon direncini arttırıcı zincoprım uygulanır
LED sürücüsü dahil

Material : Die-cast aluminium and extruded body, tempered glass, galvanized metal anchorage

Color : Graphite, Metallik Grey, Black

For corrosion resistance, zincoprım applied to surface of the luminaire before elektrostatik powder coating With LED driver

GM054L20

COB LED



9ANK09

Ankraj / Anchorage



IP 65





NERIUM

Led Tipi Led Type	Renk Isısı Color Temperature	Toplam Güç Total Power	Akım Current	Voltaj Voltage	Toplam Lümen Total Lumen
Middle Power LED	3000K	16W	116mA	220V AC	1320lm
Middle Power LED	4000K	16W	116mA	220V AC	1460lm

Malzeme : Alüminyum profil ve enjeksiyon gövde, akrilik difüzör, galvanizli metal ankraj

Renk : Füme, Metalik Gri, Siyah

Armatürün yüzeyine elektrostatik toz boyadan önce korozyon direncini artırıcı zincoprım uygulanır
LED sürücüsü dahil

Material : Die-cast aluminium and extruded body, acrylic diffuser, galvanized metal anchorage

Color : Graphite, Metalik Grey, Black

For corrosion resistance, zincoprım applied to surface of the luminarie before elektrostatik
powder coating With LED driver

GM054L21

MIDDLE POWER LED



9ANK03

Ankraj / Anchorage



IP 65



SQUARE MUSHROOM



Led Tipi Led Type	Renk Isısı Color Temperature	Toplam Güç Total Power	Akım Current	Voltaj Voltage	Toplam Lümen Total Lumen
Power LED	3000K	20W	500mA	220V AC	1896lm
Power LED	4000K	20W	500mA	220V AC	2116lm
Power LED	6500K	20W	500mA	220V AC	2384lm



Malzeme : Alüminyum profil ve enjeksiyon gövde, akrilik difüzör, galvanizli metal ankraj

Renk : Füme, Metalik Gri, Siyah

Armatürün yüzeyine elektrostatik toz boyadan önce korozyon direncini artırıcı zincoprım uygulanır
LED sürücüsü dahil

Material : Die-cast aluminium and extruded body, acrylic diffuser, galvanized metal anchorage

Color : Graphite, Metalik Grey, Black

For corrosion resistance, zincoprım applied to surface of the luminarie before elektrostatik powder coating With LED driver

GM054L22

POWER LED



9ANK09

Ankraj / Anchorage



IP 65





FAGUS

Led Tipi Led Type	Renk Isısı Color Temperature	Toplam Güç Total Power	Akım Current	Voltaj Voltage	Toplam Lümen Total Lumen
Middle Power LED	3000K	22W	116mA	220V AC	1905lm
Middle Power LED	4000K	22W	116mA	220V AC	2087lm



Malzeme : Alüminyum profil ve enjeksiyon gövde, akrilik difüzör, galvanizli metal ankraj

Renk : Füme, Metalik Gri, Siyah

Armatürün yüzeyine elektrostatik toz boyadan önce korozyon direncini artırıcı zincoprım uygulanır
LED sürücüsü dahil

Material : Die-cast aluminium and extruded body, acrylic diffuser, galvanized metal anchorage

Color : Graphite, Metallik Grey, Black

For corrosion resistance, zincoprım applied to surface of the luminaire before electrostatik powder coating With LED driver

GM054L25

MIDDLE POWER LED



9ANK09

Ankraj / Anchorage



IP 54



CEDRUS



Led Tipi Led Type	Renk Isısı Color Temperature	Toplam Güç Total Power	Akım Current	Voltaj Voltage	Toplam Lümen Total Lumen
Middle Power LED	3000K	22W	116mA	220V AC	1905lm
Middle Power LED	4000K	22W	116mA	220V AC	2087lm



Malzeme : Alüminyum profil ve enjeksiyon gövde, akrilik difüzör, galvanizli metal ankraj

Renk : Füme, Metalik Gri, Siyah

Armatürün yüzeyine elektrostatik toz boyadan önce korozyon direncini artırıcı zincoprım uygulanır
LED sürücüsü dahil

Material : Die-cast aluminium and extruded body, acrylic diffuser, galvanized metal anchorage

Color : Graphite, Metalik Grey, Black

For corrosion resistance, zincoprım applied to surface of the luminarie before elektrostatik
powder coating With LED driver

GM054L26

MIDDLE POWER LED



9ANK09

Ankraj / Anchorage



IP 54





SALICE

Led Tipi Led Type	Renk Isısı Color Temperature	Toplam Güç Total Power	Akım Current	Voltaj Voltage	Toplam Lümen Total Lumen
Middle Power LED	3000K	34W	116mA	220V AC	2970lm
Middle Power LED	4000K	34W	116mA	220V AC	3255lm

Malzeme : Alüminyum profil ve enjeksiyon gövde, akrilik difüzör, galvanizli metal ankraj

Renk : Füme, Metalik Gri, Siyah

Armatürün yüzeyine elektrostatik toz boyadan önce korozyon direncini artırıcı zincoprım uygulanır
LED sürücüsü dahil

Material : Die-cast aluminium and extruded body, acrylic diffuser, galvanized metal anchorage

Color : Graphite, Metalik Grey, Black

For corrosion resistance, zincoprım applied to surface of the luminarie before elektrostatik
powder coating With LED driver

GM054L27

MIDDLE POWER LED



9ANK03

Ankraj / Anchorage



IP 65





MORUS

Led Tipi Led Type	Renk Isısı Color Temperature	Toplam Güç Total Power	Akım Current	Voltaj Voltage	Toplam Lümen Total Lumen
Middle Power LED	3000K	11W	116mA	220V AC	953lm
Middle Power LED	4000K	11W	116mA	220V AC	1044lm

Malzeme : Alüminyum profil gövde ve pres cam, galvanizli metal ankraj

Renk : Füme, Metalik Gri, Siyah

Armatürün yüzeyine elektrostatik toz boyadan önce korozyon direncini arttırıcı zincoprım uygulanır
LED sürücüsü dahil

Material : Extruded aluminium body and pressed glass, galvanized metal anchorage

Color : Graphite, Metalik Grey, Black

For corrosion resistance, zincoprım applied to surface of the luminarie before elektrostatik
powder coating With LED driver

GM054L29

MIDDLE POWER LED

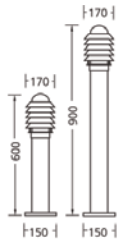

9ANK01

Ankraj / Anchorage



IP 44



FAGUS

Led Tipi Led Type	Renk Isısı Color Temperature	Toplam Güç Total Power	Akım Current	Voltaj Voltage	Toplam Lümen Total Lumen
Middle Power LED	3000K	22W	116mA	220V AC	1905lm
Middle Power LED	4000K	22W	116mA	220V AC	2087lm



Malzeme : Alüminyum profil ve enjeksiyon gövde, akrilik difüzör, galvanizli metal ankraj

Renk : Füme, Metalik Gri, Siyah

Armatürün yüzeyine elektrostatik toz boyadan önce korozyon direncini artırıcı zincoprım uygulanır
LED sürücüsü dahil

Material : Die-cast aluminium and extruded body, acrylic diffuser, galvanized metal anchorage

Color : Graphite, Metallik Grey, Black

For corrosion resistance, zincoprım applied to surface of the luminaire before elektrostatik powder coating With LED driver



GM054L30

MIDDLE POWER LED

9ANK10

Ankraj / Anchorage



IP 54



BETULA

Led Tipi Led Type	Renk Isısı Color Temperature	Toplam Güç Total Power	Akım Current	Voltaj Voltage	Toplam Lümen Total Lumen
Middle Power LED	3000K	16W	116mA	220V AC	1320lm
Middle Power LED	4000K	16W	116mA	220V AC	1460lm

Malzeme : Alüminyum profil ve enjeksiyon gövde, akrilik difüzör, galvanizli metal ankraj

Renk : Füme, Metalik Gri, Siyah

Armatürün yüzeyine elektrostatik toz boyadan önce korozyon direncini artırıcı zincoprım uygulanır
LED sürücüsü dahil

Material : Die-cast aluminium and extruded body, acrylic diffuser, galvanized metal anchorage

Color : Graphite, Metalik Grey, Black

For corrosion resistance, zincoprım applied to surface of the luminarie before elektrostatik powder coating With LED driver



GM054L31

MIDDLE POWER LED

9ANK10

Ankraj / Anchorage



IP 65





NERIUM

Led Tipi Led Type	Renk Isısı Color Temperature	Toplam Güç Total Power	Akım Current	Voltaj Voltage	Toplam Lümen Total Lumen
Middle Power LED	3000K	16W	116mA	220V AC	1320lm
Middle Power LED	4000K	16W	116mA	220V AC	1460lm

Malzeme : Alüminyum profil ve enjeksiyon gövde, akrilik difüzör, galvanizli metal ankraj

Renk : Füme, Metalik Gri, Siyah

Armatürün yüzeyine elektrostatik toz boyadan önce korozyon direncini artırıcı zincoprım uygulanır
LED sürücüsü dahil

Material : Die-cast aluminium and extruded body, acrylic diffuser, galvanized metal anchorage

Color : Graphite, Metalik Grey, Black

For corrosion resistance, zincoprım applied to surface of the luminarie before elektrostatik powder coating With LED driver

GM054L32

MIDDLE POWER LED



9ANK13

Ankraj / Anchorage

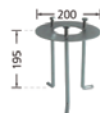

IP 65



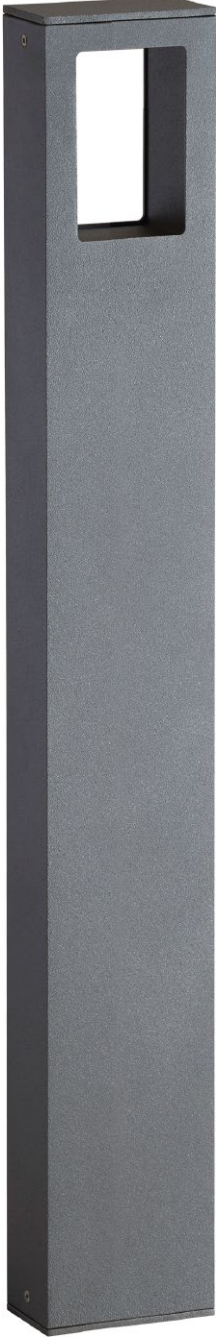

SEQUOIA

Led Tipi Led Type	Renk Isısı Color Temperature	Toplam Güç Total Power	Akım Current	Voltaj Voltage	Toplam Lümen Total Lumen
COB LED	3000K	8W	350mA	220V AC	669lm
COB LED	4000K	8W	350mA	220V AC	700lm

Malzeme : Alüminyum profil ve enjeksiyon gövde, akrilik difüzör, galvanizli metal ankraj

Renk : Füme, Metalik Gri, Siyah

Armatürün yüzeyine elektrostatik toz boyadan önce korozyon direncini artırıcı zincoprım uygulanır
LED sürücüsü dahil

Material : Die-cast aluminium and extruded body, acrylic diffuser, galvanized metal anchorage

Color : Graphite, Metalik Grey, Black

For corrosion resistance, zincoprım applied to surface of the luminarie before elektrostatik
powder coating With LED driver

GM054L36

COB LED



9ANK17

Ankraj / Anchorage



IP 54



ABIES

Led Tipi Led Type	Renk Isısı Color Temperature	Toplam Güç Total Power	Akım Current	Voltaj Voltage	Toplam Lümen Total Lumen
Middle Power LED	3000K	66W	116mA	220V AC	5940lm
Middle Power LED	4000K	66W	116mA	220V AC	6510lm

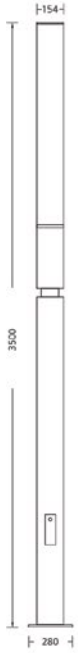

Malzeme : Alüminyum profil ve enjeksiyon gövde, akrilik difüzör, galvanizli metal ankraj

Renk : Füme, Metalik Gri, Siyah

Armatürün yüzeyine elektrostatik toz boyadan önce korozyon direncini artırıcı zincoprım uygulanır
LED sürücüsü dahil

Material : Die-cast aluminium and extruded body, acrylic diffuser, galvanized metal anchorage

Color : Graphite, Metalik Grey, Black

For corrosion resistance, zincoprım applied to surface of the luminarie before elektrostatik powder coating With LED driver

GM954L01

9ANK05

Ankraj / Anchorage

MIDDLE POWER LED



IP 65



GINEPRO

Led Tipi Led Type	Renk Isısı Color Temperature	Toplam Güç Total Power	Akım Current	Voltaj Voltage	Toplam Lümen Total Lumen
COB LED	3000K	21W	500mA	220V AC	2260lm
COB LED	4000K	21W	500mA	220V AC	2456lm
COB LED	6000K	21W	500mA	220V AC	2456lm

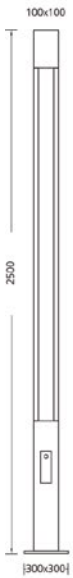

Malzeme : Alüminyum profil ve enjeksiyon gövde, ısıya dayanıklı cam, galvanizli metal ankraj

Renk : Füme, Metalik Gri, Siyah

Armatürün yüzeyine elektrostatik toz boyadan önce korozyon direncini artırıcı zincoprım uygulanır
LED sürücüsü dahil

Material : Die-cast aluminium and extruded body, tempered glass, galvanized metal anchorage

Color : Graphite, Metalik Grey, Black

For corrosion resistance, zincoprım applied to surface of the luminarie before elektrostatik
powder coating With LED driver

GM954L02

9ANK11

Ankraj / Anchorage

COB LED



IP 65



MYSIA

Led Tipi Led Type	Renk Isısı Color Temperature	Toplam Güç Total Power	Akım Current	Voltaj Voltage	Toplam Lümen Total Lumen
Middle Power LED	3000K	44W	116mA	220V AC	3810lm
Middle Power LED	4000K	44W	116mA	220V AC	4174lm

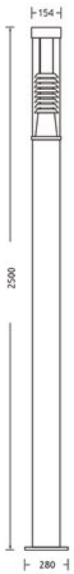

Malzeme : Alüminyum profil ve enjeksiyon gövde, alüminyum reflektör ve polikarbonat difüzör, galvanizli metal ankraj

Renk : Füme, Metalik Gri, Siyah

Armatürün yüzeyine elektrostatik toz boyadan önce korozyon direncini artırıcı zincoprım uygulanır LED sürücüsü dahil

Material : Die-cast aluminium and extruded body, aluminium reflector and polycarbonate diffuser, galvanized metal anchorage

Color : Graphite, Metallik Grey, Black

For corrosion resistance, zincoprım applied to surface of the luminarie before elektrostatik powder coating With LED driver

GM954L03

9ANK05

Ankraj / Anchorage

MIDDLE POWER LED



IP 65



FAGUS

Led Tipi Led Type	Renk Isısı Color Temperature	Toplam Güç Total Power	Akım Current	Voltaj Voltage	Toplam Lümen Total Lumen
Middle Power LED	3000K	66W	116mA	220V AC	5940lm
Middle Power LED	4000K	66W	116mA	220V AC	6510lm



Malzeme : Alüminyum profil ve enjeksiyon gövde, alüminyum reflektör ve akrilik difüzör, galvanizli metal ankraj

Renk : Füme, Metalik Gri, Siyah

Armatürün yüzeyine elektrostatik toz boyadan önce korozyon direncini artırıcı zincoprım uygulanır LED sürücüsü dahil

Material : Die-cast aluminium and extruded body, aluminium reflector and acrylic diffuser, galvanized metal anchorage

Color : Graphite, Metalik Grey, Black

For corrosion resistance, zincoprım applied to surface of the luminarie before elektrostatik powder coating With LED driver

GM954L05

9ANK11

Ankraj / Anchorage

MIDDLE POWER LED



IP 65



GINEPRO

Led Tipi Led Type	Renk Isısı Color Temperature	Toplam Güç Total Power	Akım Current	Voltaj Voltage	Toplam Lümen Total Lumen
COB LED	3000K	32W	1050mA	220V AC	3270lm
COB LED	4000K	32W	1050mA	220V AC	3450lm
COB LED	5000K	32W	1050mA	220V AC	3500lm

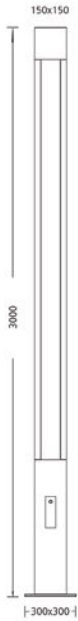

Malzeme : Alüminyum profil ve enjeksiyon gövde, ısıya dayanıklı cam, galvanizli metal ankraj

Renk : Füme, Metalik Gri, Siyah

Armatürün yüzeyine elektrostatik toz boyadan önce korozyon direncini artırıcı zincoprım uygulanır
LED sürücüsü dahil

Material : Die-cast aluminium and extruded body, tempered glass, galvanized metal anchorage

Color : Graphite, Metallik Grey, Black

For corrosion resistance, zincoprım applied to surface of the luminaire before electrostatik
powder coating With LED driver

GM954L06

9ANK11

Ankraj / Anchorage

COB LED



IP 65



CEDRUS

Led Tipi Led Type	Renk Isısı Color Temperature	Toplam Güç Total Power	Akım Current	Voltaj Voltage	Toplam Lümen Total Lumen
Middle Power LED	3000K	66W	116mA	220V AC	5940lm
Middle Power LED	4000K	66W	116mA	220V AC	6510lm



Malzeme : Alüminyum profil ve enjeksiyon gövde, alüminyum reflektör ve akrilik difüzör, galvanizli metal ankraj

Renk : Füme, Metalik Gri, Siyah

Armatürün yüzeyine elektrostatik toz boyadan önce korozyon direncini artırıcı zincoprım uygulanır LED sürücüsü dahil

Material : Die-cast aluminium and extruded body, aluminium reflector and acrylic diffuser, galvanized metal anchorage

Color : Graphite, Metalik Grey, Black

For corrosion resistance, zincoprım applied to surface of the luminarie before elektrostatik powder coating With LED driver

GM954L07

9ANK11

Ankraj / Anchorage

MIDDLE POWER LED



IP 65



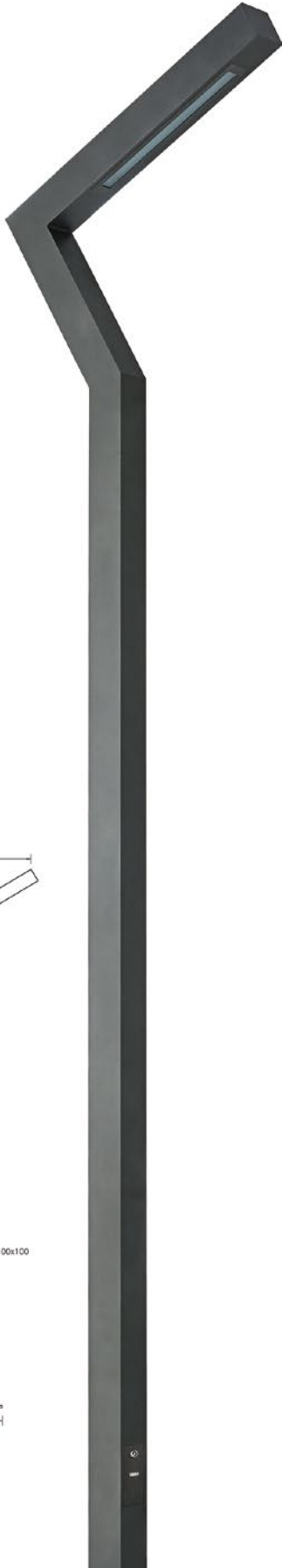

TILIA

Led Tipi Led Type	Renk Isısı Color Temperature	Toplam Güç Total Power	Akım Current	Voltaj Voltage	Toplam Lümen Total Lumen
Power LED	3000K	54W	700mA	220V AC	4916lm
Power LED	4000K	54W	700mA	220V AC	5520lm
Power LED	6500K	54W	700mA	220V AC	6134lm

Malzeme : Alüminyum profil ve enjeksiyon gövde, akrilik difüzör, galvanizli metal ankraj

Renk : Füme, Metalik Gri, Siyah

Armatürün yüzeyine elektrostatik toz boyadan önce korozyon direncini artırıcı zincoprım uygulanır
LED sürücüsü dahil

Material : Die-cast aluminium and extruded body, acrylic diffuser, galvanized metal anchorage

Color : Graphite, Metallik Grey, Black

For corrosion resistance, zincoprım applied to surface of the luminarie before elektrostatik powder coating With LED driver

GM954L08

9ANK11

Ankraj / Anchorage

POWER LED



IP 65



CARPINUS

Led Tipi Led Type	Renk Isısı Color Temperature	Toplam Güç Total Power	Akım Current	Voltaj Voltage	Toplam Lümen Total Lumen
Power LED	3000K	54W	700mA	220V AC	4916lm
Power LED	4000K	54W	700mA	220V AC	5520lm
Power LED	6500K	54W	700mA	220V AC	6134lm



Malzeme : Alüminyum profil ve enjeksiyon gövde, akrilik difüzör, galvanizli metal ankraj

Renk : Füme, Metalik Gri, Siyah

Armatürün yüzeyine elektrostatik toz boyadan önce korozyon direncini arttırıcı zincoprım uygulanır
LED sürücüsü dahil

Material : Die-cast aluminium and extruded body, acrylic diffuser, galvanized metal anchorage

Color : Graphite, Metallik Grey, Black

For corrosion resistance, zincoprım applied to surface of the luminarie before elektrostatik
powder coating With LED driver

GM954L10

9ANK11

Ankraj / Anchorage

POWER LED



IP 65



CARPINUS

Led Tipi Led Type	Renk Isısı Color Temperature	Toplam Güç Total Power	Akım Current	Voltaj Voltage	Toplam Lümen Total Lumen
Power LED	3000K	2X54W	700mA	220V AC	2X4916lm
Power LED	4000K	2X54W	700mA	220V AC	2X5520lm
Power LED	6500K	2X54W	700mA	220V AC	2X6134lm

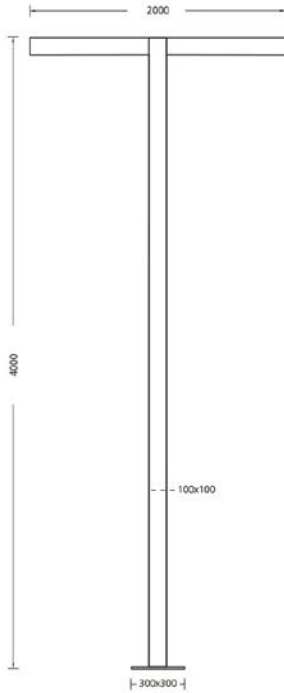

Malzeme : Alüminyum profil ve enjeksiyon gövde, alüminyum reflektör ve akrilik difüzör, galvanizli metal ankraj

Renk : Füme, Metalik Gri, Siyah

Armatürün yüzeyine elektrostatik toz boyadan önce korozyon direncini artırıcı zincoprım uygulanır LED sürücüsü dahil

Material : Die-cast aluminium and extruded body, aluminium reflector and acrylic diffuser, galvanized metal anchorage

Color : Graphite, Metallik Grey, Black

For corrosion resistance, zincoprım applied to surface of the luminarie before elektrostatik powder coating With LED driver

GM954L11

9ANK11

Ankraj / Anchorage

POWER LED



IP 65



GINEPRO

Led Tipi Led Type	Renk Isısı Color Temperature	Toplam Güç Total Power	Akım Current	Voltaj Voltage	Toplam Lümen Total Lumen
COB LED	3000K	48W	1050mA	220V AC	4350lm
COB LED	4000K	48W	1050mA	220V AC	5155lm
COB LED	6000K	48W	1050mA	220V AC	5155lm

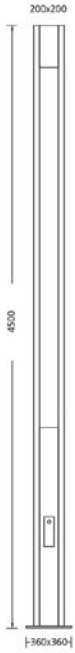

Malzeme : Alüminyum profil ve enjeksiyon gövde, ısıya dayanıklı cam, galvanizli metal ankraj

Renk : Füme, Metalik Gri, Siyah

Armatürün yüzeyine elektrostatik toz boyadan önce korozyon direncini artırıcı zincoprım uygulanır
LED sürücüsü dahil

Material : Die-cast aluminium and extruded body, tempered glass, galvanized metal anchorage

Color : Graphite, Metallik Grey, Black

For corrosion resistance, zincoprım applied to surface of the luminaire before electrostatik
powder coating With LED driver

GM954L12

9ANK14

Ankraj / Anchorage

COB LED



IP 65



SALICE

Led Tipi Led Type	Renk Isısı Color Temperature	Toplam Güç Total Power	Akım Current	Voltaj Voltage	Toplam Lümen Total Lumen
Middle Power LED	3000K	66W	116mA	220V AC	5940lm
Middle Power LED	4000K	66W	116mA	220V AC	6510lm

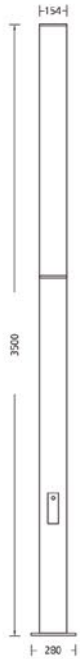

Malzeme : Alüminyum profil ve enjeksiyon gövde, akrilik difüzör, galvanizli metal ankraj

Renk : Füme, Metalik Gri, Siyah

Armatürün yüzeyine elektrostatik toz boyadan önce korozyon direncini artırıcı zincoprım uygulanır
LED sürücüsü dahil

Material : Die-cast aluminium and extruded body, acrylic diffuser, galvanized metal anchorage

Color : Graphite, Metalik Grey, Black

For corrosion resistance, zincoprım applied to surface of the luminarie before elektrostatik
powder coating With LED driver

GM954L13

9ANK05

Ankraj / Anchorage

MIDDLE POWER LED



IP 54



MITRA

Led Tipi Led Type	Renk Isısı Color Temperature	Toplam Güç Total Power	Akım Current	Voltaj Voltage	Toplam Lümen Total Lumen
Power LED	3000K	82W	700mA	220V AC	7374lm
Power LED	4000K	82W	700mA	220V AC	8280lm
Power LED	6500K	82W	700mA	220V AC	9261lm



Malzeme : Alüminyum profil ve enjeksiyon gövde, akrilik difüzör, galvanizli metal ankraj

Renk : Füme, Metalik Gri, Siyah

Armatürün yüzeyine elektrostatik toz boyadan önce korozyon direncini artırıcı zincoprım uygulanır
LED sürücüsü dahil

Material : Die-cast aluminium and extruded body, acrylic diffuser, galvanized metal anchorage

Color : Graphite, Metallik Grey, Black

For corrosion resistance, zincoprım applied to surface of the luminarie before elektrostatik
powder coating With LED driver

GM954L15

9ANK14

Ankraj / Anchorage

POWER LED



IP 65



MITRA

Led Tipi Led Type	Renk Isısı Color Temperature	Toplam Güç Total Power	Akım Current	Voltaj Voltage	Toplam Lümen Total Lumen
Power LED	3000K	2X82W	700mA	220V AC	2X7374lm
Power LED	4000K	2X82W	700mA	220V AC	2X8280lm
Power LED	6500K	2X82W	700mA	220V AC	2X9261lm

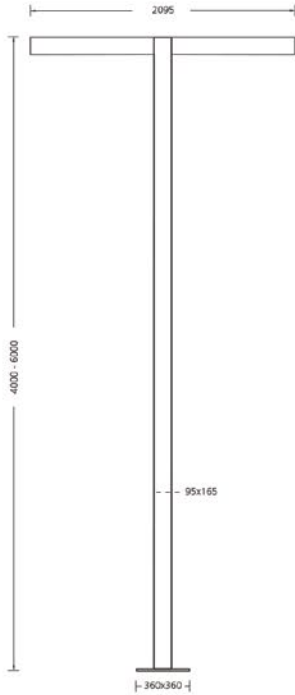

Malzeme : Alüminyum profil ve enjeksiyon gövde, akrilik difüzör, galvanizli metal ankraj

Renk : Füme, Metalik Gri, Siyah

Armatürün yüzeyine elektrostatik toz boyadan önce korozyon direncini arttırıcı zincoprım uygulanır
LED sürücüsü dahil

Material : Die-cast aluminium and extruded body, acrylic diffuser, galvanized metal anchorage

Color : Graphite, Metalik Grey, Black

For corrosion resistance, zincoprım applied to surface of the luminarie before elektrostatik
powder coating With LED driver

GM954L16

9ANK14

Ankraj / Anchorage

POWER LED



IP 65



MITRA

Led Tipi Led Type	Renk Isısı Color Temperature	Toplam Güç Total Power	Akım Current	Voltaj Voltage	Toplam Lümen Total Lumen
Power LED	3000K	2X82W	700mA	220V AC	2X7374lm
Power LED	4000K	2X82W	700mA	220V AC	2X8280lm
Power LED	6500K	2X82W	700mA	220V AC	2X9261lm

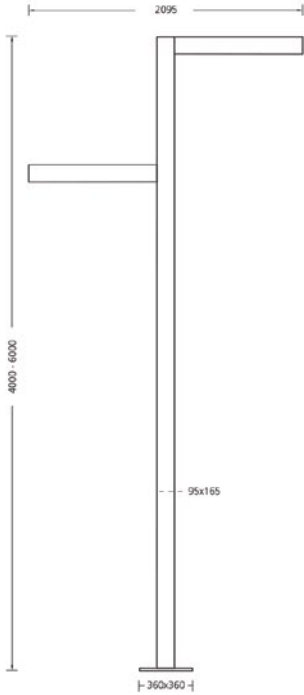

Malzeme : Alüminyum profil ve enjeksiyon gövde, akrilik difüzör, galvanizli metal ankraj

Renk : Füme, Metalik Gri, Siyah

Armatürün yüzeyine elektrostatik toz boyadan önce korozyon direncini arttırıcı zincoprım uygulanır
LED sürücüsü dahil

Material : Die-cast aluminium and extruded body, acrylic diffuser, galvanized metal anchorage

Color : Graphite, Metallik Grey, Black

For corrosion resistance, zincoprım applied to surface of the luminarie before elektrostatik
powder coating With LED driver

GM954L17

9ANK14

Ankraj / Anchorage

POWER LED



IP 65





MITRA

Led Tipi Led Type	Renk Isısı Color Temperature	Toplam Güç Total Power	Akım Current	Voltaj Voltage	Toplam Lümen Total Lumen
Power LED	3000K	54W	700mA	220V AC	4916lm
Power LED	4000K	54W	700mA	220V AC	5520lm
Power LED	6500K	54W	700mA	220V AC	6134lm



Malzeme : Alüminyum üst başlık, ısıya dayanıklı cam ve çelik boru direk gövdesi, galvanizli metal ankraj

Renk : Füme, Metalik Gri, Siyah

Armatürün yüzeyine elektrostatik toz boyadan önce korozyon direncini artırıcı zincoprım uygulanır LED sürücüsü dahil

Material : Aluminium head, tempered glass and pole body made of steel tube, galvanized metal anchorage

Color : Graphite, Metalik Grey, Black

For corrosion resistance, zincoprım applied to surface of the luminaire before electrostatik powder coating With LED driver

GM954L18

9ANK05

Ankraj / Anchorage

POWER LED



IP 65



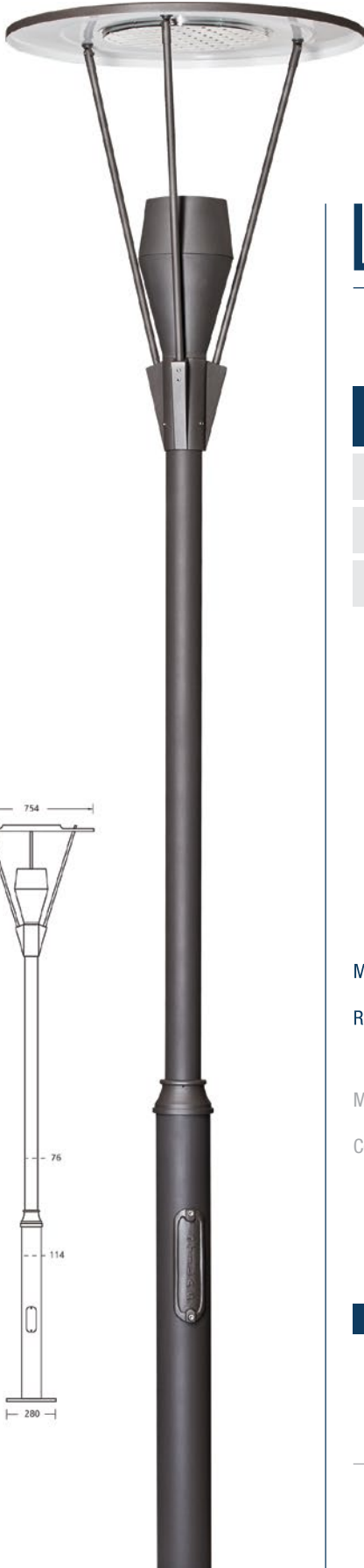

LETO

Led Tipi Led Type	Renk Isısı Color Temperature	Toplam Güç Total Power	Akım Current	Voltaj Voltage	Toplam Lümen Total Lumen
Power LED	3000K	45W	700mA	220V AC	3687lm
Power LED	4000K	45W	700mA	220V AC	4140lm
Power LED	6500K	45W	700mA	220V AC	4630lm

Malzeme : Polimer üst başlık ve alüminyum iç reflektör, alüminyum indirek üst yansıtıcı ve çelik boru direk gövdesi, galvanizli metal ankraj

Renk : Füme, Metalik Gri, Siyah

Armatürün yüzeyine elektrostatik toz boyadan önce korozyon direncini artırıcı zincoprım uygulanır LED sürücüsü dahil

Material : Polimer upper head aluminium inner reflector, aluminium indirect upper reflector and pole body made of steel tube, galvanized metal anchorage

Color : Graphite, Metalik Grey, Black

For corrosion resistance, zincoprım applied to surface of the luminarie before elektrostatik powder coating With LED driver

GM954L21

9ANK05

Ankraj / Anchorage

POWER LED



IP 65





MITRA

Led Tipi Led Type	Renk Isısı Color Temperature	Toplam Güç Total Power	Akım Current	Voltaj Voltage	Toplam Lümen Total Lumen
COB LED	3000K	48W	1050mA	220V AC	4350lm
COB LED	4000K	48W	1050mA	220V AC	5155lm
COB LED	6000K	48W	1050mA	220V AC	5155lm

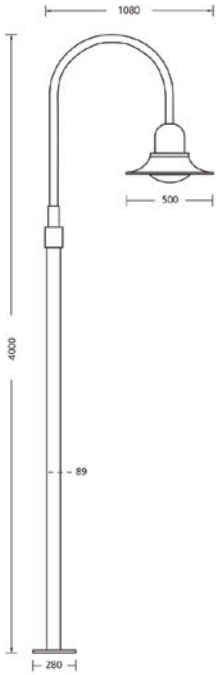

Malzeme : Üst başlık alüminyum enjeksiyon ve polibarbonat difüzör, alüminyum iç reflektör ve çelik boru direk gövdesi, galvanizli metal ankraj

Renk : Füme, Metalik Gri, Siyah

Armatürün yüzeyine elektrostatik toz boyadan önce korozyon direncini artırıcı zincoprım uygulanır LED sürücüsü dahil

Material : Die-cast aluminium and polycarbonate diffuser upper head, aluminium inner reflector and pole body made of steel tube, galvanized metal anchorage

Color : Graphite, Metalik Grey, Black

For corrosion resistance, zincoprım applied to surface of the luminarie before elektrostatik powder coating With LED driver

GM954L22

9ANK05

Ankraj / Anchorage

COB LED



IP 65



DOR

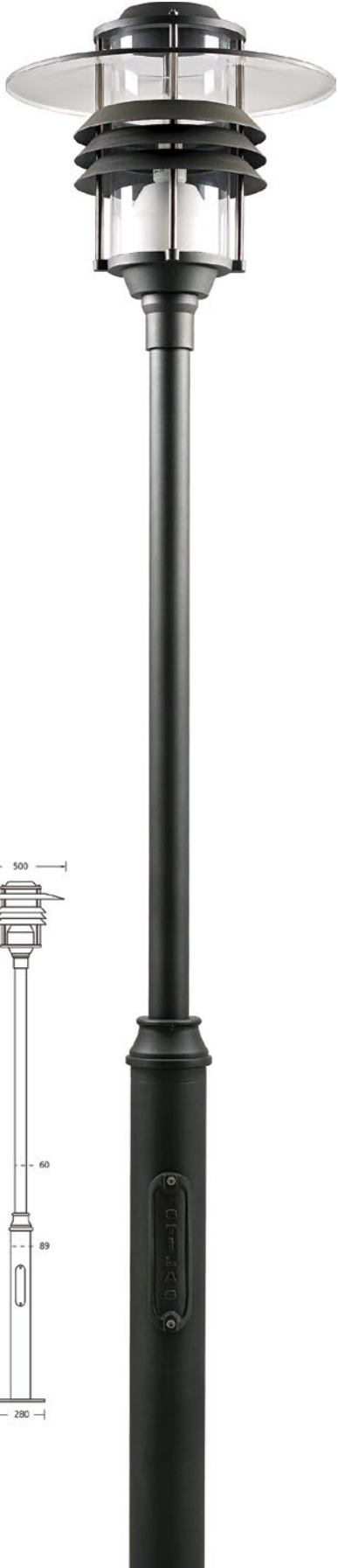

Led Tipi Led Type	Renk Isısı Color Temperature	Toplam Güç Total Power	Akım Current	Voltaj Voltage	Toplam Lümen Total Lumen
Middle Power LED	3000K	44W	116mA	220V AC	3810lm
Middle Power LED	4000K	44W	116mA	220V AC	4174lm

Malzeme : Üst başlık alüminyum enjeksiyon ve polibarbonat difüzör, alüminyum iç reflektör ve çelik boru direk gövdesi, galvanizli metal ankraj

Renk : Füme, Metalik Gri, Siyah

Armatürün yüzeyine elektrostatik toz boyadan önce korozyon direncini artırıcı zincoprım uygulanır LED sürücüsü dahil

Material : Die-cast aluminium and polycarbonate diffuser upper head, aluminium inner reflector and pole body made of steel tube, galvanized metal anchorage

Color : Graphite, Metalik Grey, Black

For corrosion resistance, zincoprım applied to surface of the luminarie before elektrostatik powder coating With LED driver

GM954L23

9ANK05

Ankraj / Anchorage

MIDDLE POWER LED



IP 65



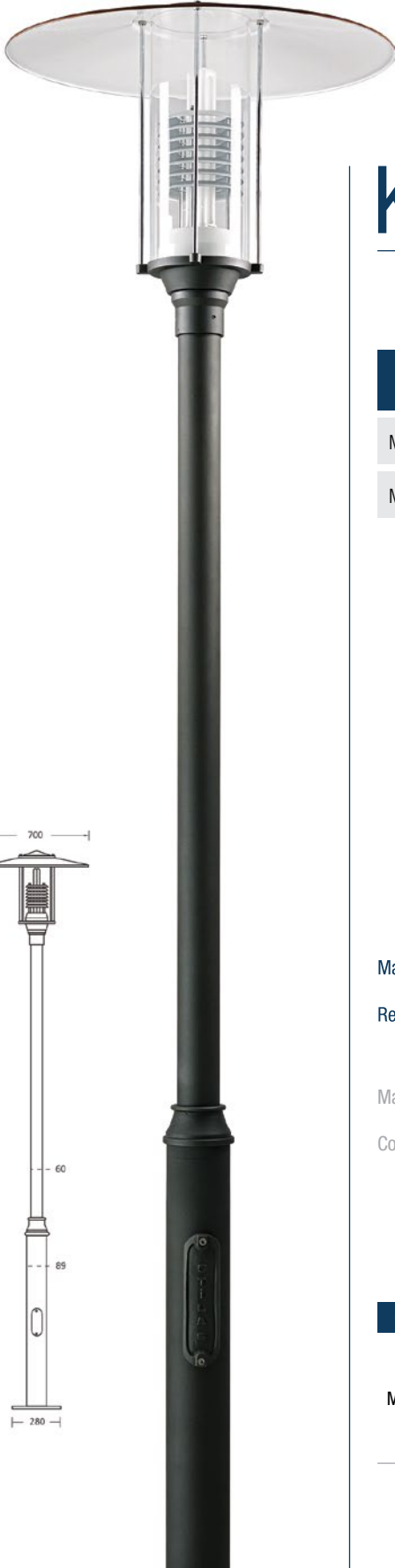

KORINT

Led Tipi Led Type	Renk Isısı Color Temperature	Toplam Güç Total Power	Akım Current	Voltaj Voltage	Toplam Lümen Total Lumen
Middle Power LED	3000K	44W	116mA	220V AC	3810lm
Middle Power LED	4000K	44W	116mA	220V AC	4174lm



Malzeme : Üst başlık alüminyum enjeksiyon ve polibarbonat difüzör, alüminyum iç reflektör ve çelik boru direk gövdesi, galvanizli metal ankraj

Renk : Füme, Metalik Gri, Siyah

Armatürün yüzeyine elektrostatik toz boyadan önce korozyon direncini artırıcı zincoprim uygulanır LED sürücüsü dahil

Material : Die-cast aluminium and polycarbonate diffuser upper head, aluminium inner reflector and pole body made of steel tube, galvanized metal anchorage

Color : Graphite, Metalik Grey, Black

For corrosion resistance, zincoprim applied to surface of the luminarie before elektrostatik powder coating With LED driver

GM954L24

9ANK05

Ankraj / Anchorage

MIDDLE POWER LED



IP 65





IYON

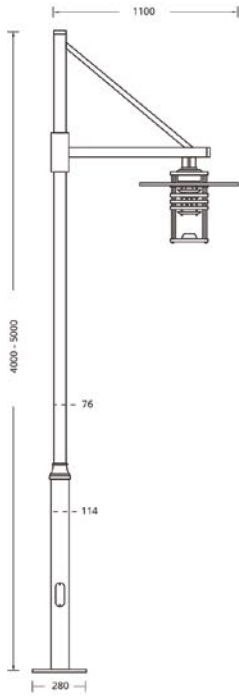

Led Tipi Led Type	Renk Isısı Color Temperature	Toplam Güç Total Power	Akım Current	Voltaj Voltage	Toplam Lümen Total Lumen
Middle Power LED	3000K	44W	116mA	220V AC	3810lm
Middle Power LED	4000K	44W	116mA	220V AC	4174lm

Malzeme : Üst başlık alüminyum enjeksiyon ve polibarbonat difüzör, alüminyum iç reflektör ve çelik boru direk gövdesi, galvanizli metal ankraj

Renk : Füme, Metalik Gri, Siyah

Armatürün yüzeyine elektrostatik toz boyadan önce korozyon direncini artırıcı zincoprım uygulanır LED sürücüsü dahil

Material : Die-cast aluminium and polycarbonate diffuser upper head, aluminium inner reflector and pole body made of steel tube, galvanized metal anchorage

Color : Graphite, Metalik Grey, Black

For corrosion resistance, zincoprım applied to surface of the luminarie before elektrostatik powder coating With LED driver

GM954L26

9ANK05

Ankraj / Anchorage

MIDDLE POWER LED



IP 65





İYON

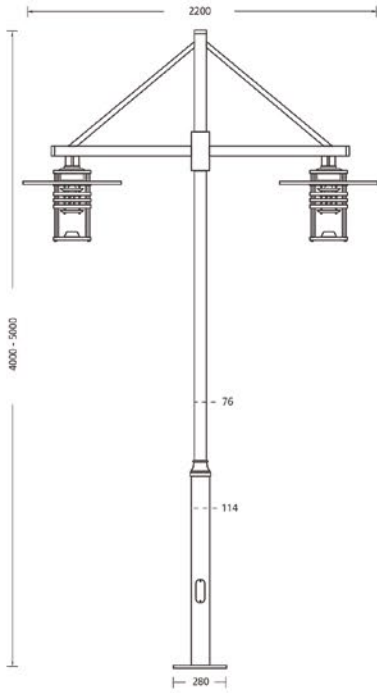

Led Tipi Led Type	Renk Isısı Color Temperature	Toplam Güç Total Power	Akım Current	Voltaj Voltage	Toplam Lümen Total Lumen
Middle Power LED	3000K	2X44W	116mA	220V AC	2X3810lm
Middle Power LED	4000K	2X44W	116mA	220V AC	2X4174lm

Malzeme : Üst başlık alüminyum enjeksiyon ve polibarbonat difüzör, alüminyum iç reflektör ve çelik boru direk gövdesi, galvanizli metal ankraj

Renk : Füme, Metalik Gri, Siyah

Armatürün yüzeyine elektrostatik toz boyadan önce korozyon direncini artırıcı zincoprim uygulanır LED sürücüsü dahil

Material : Die-cast aluminium and polycarbonate diffuser upper head, aluminium inner reflector and pole body made of steel tube, galvanized metal anchorage

Color : Graphite, Metalik Grey, Black

For corrosion resistance, zincoprim applied to surface of the luminarie before electrostatik powder coating With LED driver

GM954L27

9ANK05

Ankraj / Anchorage

MIDDLE POWER LED



IP 65





İÇ AYDINLATMALAR INTERIOR LIGHTING



Led Tipi Led Type	Renk Isısı Color Temperature	Toplam Güç Total Power	Boyutlar Size	Voltaj Voltage	Toplam Lümen Total Lumen
COB LED 24°	3000/4000K	20/30W	90/120/140mm	220V	2000/3000lm
COB LED 42°	3000/4000K	20/30W	90/120/140mm	220V	2000/3000lm

Ürün Özellikleri : Elektrostatik toz boyalı alüminyum gövde
Yüksek saflıkta alüminyum 24° 42° açılı Reflektör
Koruma sınıfı, IP20
Yüksek verimliliğe sahip LED sürücü
Yatayda 300°, dikeyde 110° yönlendirilebilme özelliği
Işıl iletkenliği yüksek COB led
1faz / 3faz ray adaptör opsiyonu

Kullanım Alanları : Alışveriş merkezleri, Mağazalar, Ofisler

Specifications : Electrostatic anodized aluminum body
Highly pure aluminium 24° 42° angled reflector
Protection Class, IP20
High Efficiency LED Driver
High Luminosity COB LED
Horizontally 300°, vertically 110° adjustable
1phase/3phases adapter option

Usage : Shopping Malls, Stores, Offices

GM300L01

COB LED

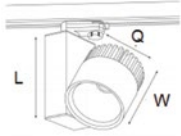

Led Tipi Led Type	Renk Isısı Color Temperature	Toplam Güç Total Power	Boyutlar Size	Voltaj Voltage	Toplam Lümen Total Lumen
COB LED 24°	3000/4000K	20/30W	120/140/140mm	220V	2000/3000lm
COB LED 42°	3000/4000K	20/30W	120/140/140mm	220V	2000/3000lm

Ürün Özellikleri : Elektrostatik toz boyalı alüminyum gövde
Yüksek saflıkta alüminyum 24° 42° açılı Reflektör
Koruma sınıfı, IP20
Yüksek verimliliğe sahip LED sürücü
Yatayda 300°, dikeyde 110° yönlendirilebilme özelliği
Işıl iletkenliği yüksek COB led
1faz / 3faz ray adaptör opsiyonu

Kullanım Alanları : Alışveriş merkezleri, Mağazalar, Ofisler

Specifications : Electrostatic anodized aluminum body
Highly pure aluminium 24° 42° angled reflector
Protection Class, IP20
High Efficiency LED Driver
High Luminosity COB LED
Horizontally 300°, vertically 110° adjustable
1phase/3phases adapter option

Usage : Shopping Malls, Stores, Offices

GM300L02

COB LED

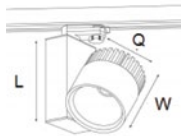



Led Tipi Led Type	Renk Isısı Color Temperature	Toplam Güç Total Power	Boyutlar Size	Voltaj Voltage	Toplam Lümen Total Lumen
COB LED 24°	3000/4000K	20/30W	125/140/140mm	220V	2000/3000lm
COB LED 42°	3000/4000K	20/30W	125/140/140mm	220V	2000/3000lm

Ürün Özellikleri : Elektrostatik toz boyalı alüminyum gövde
Yüksek saflıkta alüminyum 24° 42° açılı Reflektör
Koruma sınıfı, IP20
Yüksek verimliliğe sahip LED sürücü
Yatayda 300°, dikeyde 110° yönlendirilebilme özelliği
Işıl iletkenliği yüksek COB led
1faz / 3faz ray adaptör opsiyonu

Kullanım Alanları : Alışveriş merkezleri, Mağazalar, Ofisler

Specifications : Electrostatic anodized aluminum body
Highly pure aluminium 24° 42° angled reflector
Protection Class, IP20
High Efficiency LED Driver
High Luminosity COB LED
Horizontally 300°, vertically 110° adjustable
1phase/3phases adapter option

Usage : Shopping Malls, Stores, Offices



GM300L03

COB LED



Led Tipi Led Type	Renk Isısı Color Temperature	Toplam Güç Total Power	Boyutlar Size	Voltaj Voltage	Toplam Lümen Total Lumen
COB LED 24°	3000/4000K	20/30W	90/120/230mm	220V	2000/3000lm
COB LED 42°	3000/4000K	20/30W	90/120/230mm	220V	2000/3000lm

Ürün Özellikleri : Elektrostatik toz boyalı alüminyum gövde
Yüksek saflıkta alüminyum 24° 42° açılı Reflektör
Koruma sınıfı, IP20
Yüksek verimliliğe sahip LED sürücü
Yatayda 300°, dikeyde 110° yönlendirilebilme özelliği
Işıl iletkenliği yüksek COB led
1faz / 3faz ray adaptör opsiyonu

Kullanım Alanları : Alışveriş merkezleri, Mağazalar, Ofisler

Specifications : Electrostatic anodized aluminum body
Highly pure aluminium 24° 42° angled reflector
Protection Class, IP20
High Efficiency LED Driver
High Luminosity COB LED
Horizontally 300°, vertically 110° adjustable
1phase/3phases adapter option

Usage : Shopping Malls, Stores, Offices

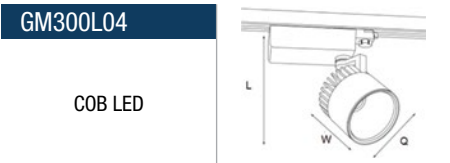

GM300L04

COB LED



Led Tipi Led Type	Renk Isısı Color Temperature	Toplam Güç Total Power	Boyutlar Size	Voltaj Voltage	Toplam Lümen Total Lumen
COB LED 24°	3000/4000K	20/30W	120/140/250mm	220V	2000/3000lm
COB LED 42°	3000/4000K	20/30W	120/140/250mm	220V	2000/3000lm

Ürün Özellikleri : Elektrostatik toz boyalı alüminyum gövde
Yüksek saflıkta alüminyum 24° 42° açılı Reflektör
Koruma sınıfı, IP20
Yüksek verimliliğe sahip LED sürücü
Yatayda 300°, dikeyde 110° yönlendirilebilme özelliği
Işıl iletkenliği yüksek COB led
1faz / 3faz ray adaptör opsiyonu

Kullanım Alanları : Alışveriş merkezleri, Mağazalar, Ofisler

Specifications : Electrostatic anodized aluminum body
Highly pure aluminium 24° 42° angled reflector
Protection Class, IP20
High Efficiency LED Driver
High Luminosity COB LED
Horizontally 300°, vertically 110° adjustable
1phase/3phases adapter option

Usage : Shopping Malls, Stores, Offices

GM300L05

COB LED

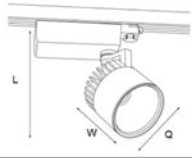

Led Tipi Led Type	Renk Isısı Color Temperature	Toplam Güç Total Power	Boyutlar Size	Voltaj Voltage	Toplam Lümen Total Lumen
COB LED 24°	3000/4000K	20/30W	125/300mm	220V	2000/3000lm
COB LED 42°	3000/4000K	20/30W	125/300mm	220V	2000/3000lm

Ürün Özellikleri : Elektrostatik toz boyalı alüminyum gövde
Yüksek saflıkta alüminyum 24° 42° açılı Reflektör
Koruma sınıfı, IP20
Yüksek verimliliğe sahip LED sürücü
Yatayda 300°, dikeyde 110° yönlendirilebilme özelliği
Işıl iletkenliği yüksek COB led
1faz / 3faz ray adaptör opsiyonu

Kullanım Alanları : Alışveriş merkezleri, Mağazalar, Ofisler

Specifications : Electrostatic anodized aluminum body
Highly pure aluminium 24° 42° angled reflector
Protection Class, IP20
High Efficiency LED Driver
High Luminosity COB LED
Horizontally 300°, vertically 110° adjustable
1phase/3phases adapter option

Usage : Shopping Malls, Stores, Offices

GM300L06

COB LED





Led Tipi Led Type	Renk Isısı Color Temperature	Toplam Güç Total Power	Boyutlar Size	Voltaj Voltage	Toplam Lümen Total Lumen
GU10 LED	2700/3000K	5.4W	60/140mm	220V	450lm
PAR30 LED	2700/3000K	14W	125/210mm	220V	960lm

Ürün Özellikleri : Elektrostatik toz boyalı alüminyum gövde,
Koruma sınıfı, IP20
Yatayda 300°, dikeyde 110° yönlendirilebilme özelliği
Işıl iletkenliği yüksek GU10/PAR30/QR111 LED Ampul
1faz / 3faz ray adaptör opsiyonu

Kullanım Alanları : Alışveriş merkezleri, Mağazalar, Ofisler

Specifications : Electrostatic anodized aluminum body
Protection Class, IP20
Horizontally 300°, vertically 110° adjustable
High Luminosity GU10/PAR30/QR111 LED Bulb
1phase/3phases adapter option

Usage : Shopping Malls, Stores, Offices

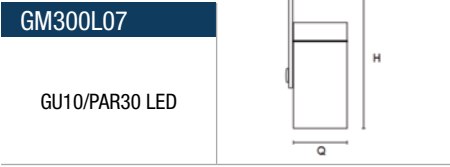

GM300L07

GU10/PAR30 LED



Led Tipi Led Type	Renk Isısı Color Temperature	Toplam Güç Total Power	Boyutlar Size	Voltaj Voltage	Toplam Lümen Total Lumen
COB LED	3000/4000K	5W	60/140mm	220V	385lm
COB LED	3000/4000K	10W	60/140mm	220V	830lm

Ürün Özellikleri : Elektrostatik toz boyalı alüminyum gövde,
Koruma sınıfı, IP20
Yatayda 300°, dikeyde 110° yönlendirilebilme özelliği
Işıl iletkenliği yüksek COB LED
1faz / 3faz ray adaptör opsiyonu

Kullanım Alanları : Alışveriş merkezleri, Mağazalar, Ofisler

Specifications : Electrostatic anodized aluminum body
Protection Class, IP20
Horizontally 300°, vertically 110° adjustable
High Luminosity COB LED
1phase/3phases adapter option

Usage : Shopping Malls, Stores, Offices

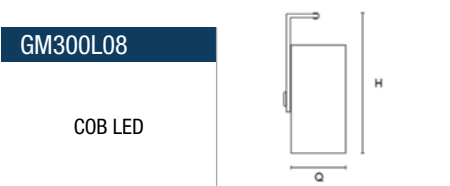

GM300L08

COB LED

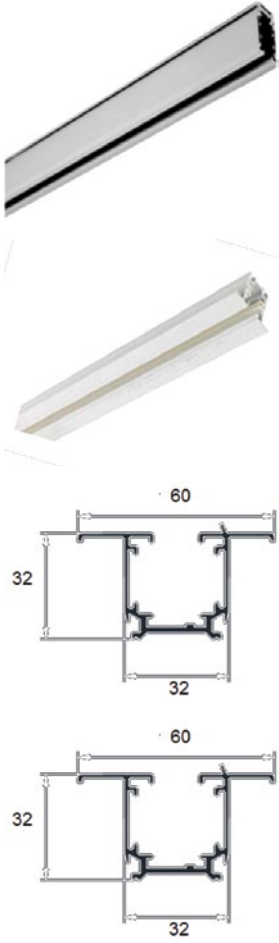
**GM300L09**

100CM SIVA ÜSTÜ 3FAZ RAY BEYAZ/SİYAH/GRİ

200CM SIVA ÜSTÜ 3FAZ RAY BEYAZ/SİYAH/GRİ

300CM SIVA ÜSTÜ 3FAZ RAY BEYAZ/SİYAH/GRİ

100CM SIVA ALTI 3FAZ RAY BEYAZ/SİYAH/GRİ

200CM SIVA ALTI 3FAZ RAY BEYAZ/SİYAH/GRİ

300CM SIVA ALTI 3FAZ RAY BEYAZ/SİYAH/GRİ

ENERJİ GİRİŞİ PARÇASI

SONLAMA KAPAĞI PARÇASI

ARA BAĞLANTI PARÇASI

L BAĞLANTI PARÇASI

L ESNEK KÖRÜK BAĞLANTI PARÇASI

T BAĞLANTI PARÇASI

X BAĞLANTI PARÇASI

2MT ÇELİK MİSİNA ASKI APARATI

RAY TAVAN TUTTURUCU PARÇASI

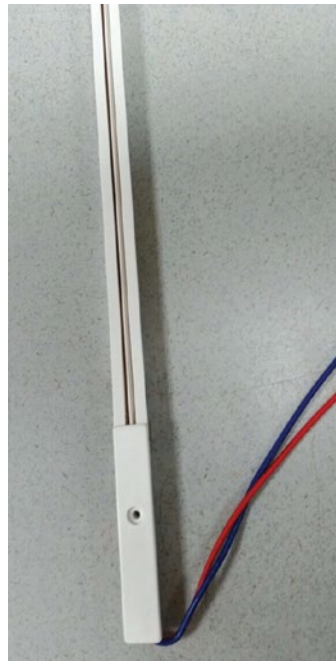

Elektro Ray ve Elektro Ray Soketi

Electro Rail and Electro Rail Socket

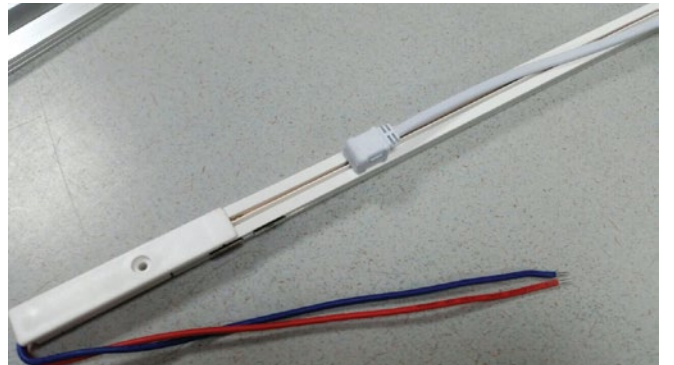



Led Tipi Led Type	Renk Isısı Color Temperature	Toplam Güç Total Power	Boyutlar Size	Voltaj Voltage	Toplam Lümen Total Lumen
PCB LED	3000/4000/6500K	45W	3X600/80/100mm	220V	3900lm
PCB LED	3000/4000/6500K	65W	3X900/80/100mm	220V	5900lm
PCB LED	3000/4000/6500K	85W	3X1200/80/100mm	220V	7900lm

Ürün Özellikleri : Elektrostatik toz boyalı alüminyum gövde
Yüksek geçirgenlikte PMMA difüzör
Ayarlanabilir çelik misina askı sistemi
Koruma sınıfı, IP20
Yüksek verimliliğe sahip LED sürücü
Işıl iletkenliği yüksek LED PCB
Acil aydınlatma kiti ilave edebilme
Dimm / Dali opsiyonu

Kullanım Alanları : Alışveriş merkezleri, Mağazalar, Ofisler

Specifications : Electrostatic anodized aluminum body
Highly permeable PMMA diffusor
Adjustable stainless-steel line hanging
Protection Class, IP20
High Efficiency LED Driver
High Luminosity LED PCB
Modular Emergency Kit
Dimm/Dali/RGB option

Usage : Shopping Malls, Stores, Offices



GM109L01

PCB LED



Led Tipi Led Type	Renk Isısı Color Temperature	Toplam Güç Total Power	Boyutlar Size	Voltaj Voltage	Toplam Lümen Total Lumen
PCB LED	3000/4000/6500K	60W	400/100mm	220V	5500lm
PCB LED	3000/4000/6500K	90W	600/100mm	220V	8300lm
PCB LED	3000/4000/6500K	120W	800/100mm	220V	11000lm
PCB LED	3000/4000/6500K	150W	1000/100mm	220V	13800lm
PCB LED	3000/4000/6500K	180W	1200/100mm	220V	16500lm
PCB LED	3000/4000/6500K	220W	1500/100mm	220V	20700lm

Ürün Özellikleri : Elektrostatik toz boyalı alüminyum gövde
Yüksek geçirgenlikte PMMA difüzör
Ayarlanabilir çelik misina askı sistemi
Koruma sınıfı, IP20
Yüksek verimliliğe sahip LED sürücü
Işıl iletkenliği yüksek LED PCB
Acil aydınlatma kiti ilave edebilme
Dimm / Dali opsiyonu

Kullanım Alanları : Alışveriş merkezleri, Mağazalar, Ofisler

Specifications : Electrostatic anodized aluminum body
Highly permeable PMMA diffusor
Adjustable stainless-steel line hanging
Protection Class, IP20
High Efficiency LED Driver
High Luminosity LED PCB
Modular Emergency Kit, Dimm/Dali/RGB option

Usage : Shopping Malls, Stores, Offices



GM109L02

PCB LED



Led Tipi Led Type	Renk Isısı Color Temperature	Toplam Güç Total Power	Boyutlar Size	Voltaj Voltage	Toplam Lümen Total Lumen
PCB LED	3000/4000/6500K	60W	600/300/100mm	220V	5500lm
PCB LED	3000/4000/6500K	108W	900/450/100mm	220V	9900lm
PCB LED	3000/4000/6500K	230W	1200/600/100mm	220V	21000lm

Ürün Özellikleri : Elektrostatik toz boyalı alüminyum gövde
Yüksek geçirgenlikte PMMA difüzör
Ayarlanabilir çelik misina askı sistemi
Koruma sınıfı, IP20
Yüksek verimliliğe sahip LED sürücü
Işıl iletkenliği yüksek LED PCB
Acil aydınlatma kiti ilave edebilme
Dimm / Dali opsiyonu

Kullanım Alanları : Alışveriş merkezleri, Mağazalar, Ofisler

Specifications : Electrostatic anodized aluminum body
Highly permeable PMMA diffusor
Adjustable stainless-steel line hanging
Protection Class, IP20
High Efficiency LED Driver
High Luminosity LED PCB
Modular Emergency Kit
Dimm/Dali/RGB option

Usage : Shopping Malls, Stores, Offices

GM109L03

PCB LED

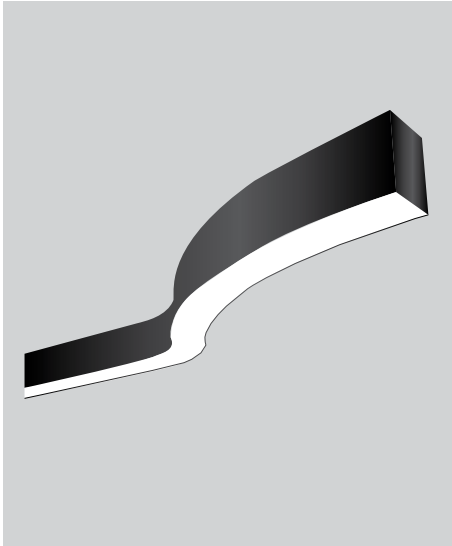
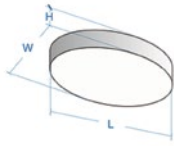

Led Tipi Led Type	Renk Isısı Color Temperature	Toplam Güç Total Power	Boyutlar Size	Voltaj Voltage	Toplam Lümen Total Lumen
PCB LED	3000/4000/6500K	60W	1200/80/100mm	220V	5280lm
PCB LED	3000/4000/6500K	72W	1500/80/100mm	220V	6600lm

Ürün Özellikleri : Elektrostatik toz boyalı alüminyum gövde
Yüksek geçirgenlikte PMMA difüzör
Ayarlanabilir çelik misina askı sistemi
Koruma sınıfı, IP20
Yüksek verimliliğe sahip LED sürücü
Işıl iletkenliği yüksek LED PCB
Acil aydınlatma kiti ilave edebilme
Dimm / Dali opsiyonu

Kullanım Alanları : Alışveriş merkezleri, Mağazalar, Ofisler

Specifications : Electrostatic anodized aluminum body
Highly permeable PMMA diffusor
Adjustable stainless-steel line hanging
Protection Class, IP20
High Efficiency LED Driver
High Luminosity LED PCB
Modular Emergency Kit
Dimm/Dali/RGB option

Usage : Shopping Malls, Stores, Offices

GM109L04

PCB LED

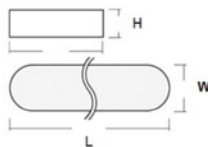

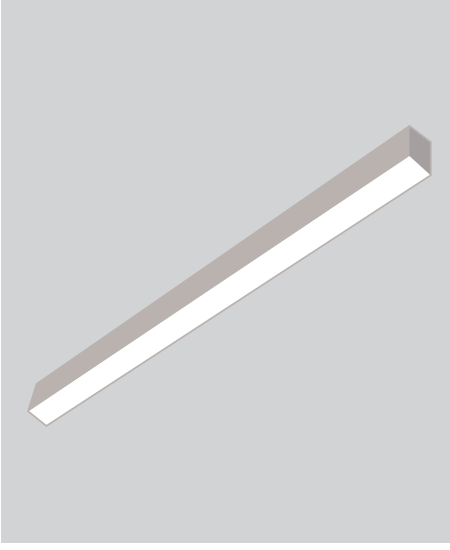

Led Tipi Led Type	Renk Isısı Color Temperature	Toplam Güç Total Power	Boyutlar Size	Voltaj Voltage	Toplam Lümen Total Lumen
PCB LED	3000/4000/6500K	18W	600/100/85mm	220V	1450lm
PCB LED	3000/4000/6500K	29W	1000/100/85mm	220V	2400lm
PCB LED	3000/4000/6500K	35W	1200/100/85mm	220V	2900lm
PCB LED	3000/4000/6500K	44W	1500/100/85mm	220V	3600lm

Ürün Özellikleri : Elektrostatik toz boyalı alüminyum gövde
Yüksek geçirgenlikte PMMA difüzör
Ayarlanabilir çelik misina askı sistemi
Koruma sınıfı, IP44
Yüksek verimliliğe sahip LED sürücü
Işıl iletkenliği yüksek LED PCB
Dimm / Dali opsiyonu

Kullanım Alanları : Alışveriş merkezleri, Mağazalar, Ofisler

Specifications : Electrostatic anodized aluminum body
Highly permeable PMMA diffusor
Adjustable stainless-steel line hanging
Protection Class, IP44
High Efficiency LED Driver
High Luminosity LED PCB
Modular Emergency Kit, Dimm/Dali/RGB option

Usage : Shopping Malls, Stores, Offices

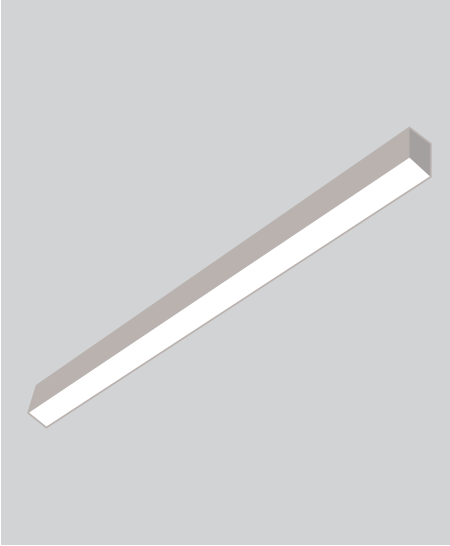

Led Tipi Led Type	Renk Isısı Color Temperature	Toplam Güç Total Power	Boyutlar Size	Voltaj Voltage	Toplam Lümen Total Lumen
PCB LED	3000/4000/6500K	18W	600/85/85mm	220V	1450lm
PCB LED	3000/4000/6500K	29W	1000/85/85mm	220V	2400lm
PCB LED	3000/4000/6500K	35W	1200/85/85mm	220V	2900lm
PCB LED	3000/4000/6500K	44W	1500/85/85mm	220V	3600lm

Ürün Özellikleri : Elektrostatik toz boyalı alüminyum gövde
Yüksek geçirgenlikte PMMA difüzör
Ayarlanabilir çelik misina askı sistemi
Koruma sınıfı, IP44
Yüksek verimliliğe sahip LED sürücü
Işıl iletkenliği yüksek LED PCB
Dimm / Dali opsiyonu

Kullanım Alanları : Alışveriş merkezleri, Mağazalar, Ofisler

Specifications : Electrostatic anodized aluminum body
Highly permeable PMMA diffusor
Adjustable stainless-steel line hanging
Protection Class, IP20
High Efficiency LED Driver
High Luminosity LED PCB
Modular Emergency Kit, Dimm/Dali/RGB option

Usage : Shopping Malls, Stores, Offices

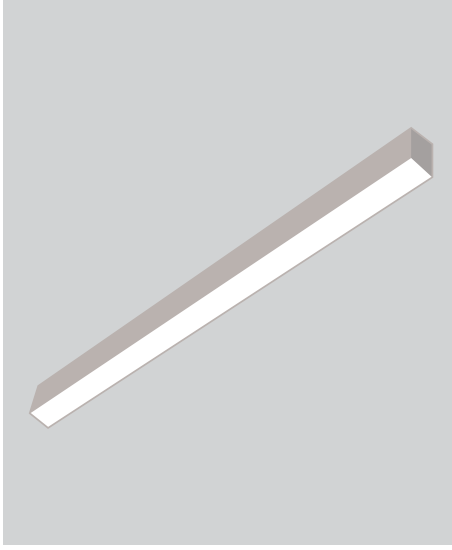

Led Tipi Led Type	Renk Isısı Color Temperature	Toplam Güç Total Power	Boyutlar Size	Voltaj Voltage	Toplam Lümen Total Lumen
PCB LED	3000/4000/6500K	9W	600/32/32mm	220V	720lm
PCB LED	3000/4000/6500K	15W	1000/32/32mm	220V	1200lm

Ürün Özellikleri : Elektrostatik toz boyalı alüminyum gövde
Yüksek geçirgenlikte PMMA difüzör
Ayarlanabilir çelik misina askı sistemi
Koruma sınıfı, IP44
Yüksek verimliliğe sahip LED sürücü
Işıl iletkenliği yüksek LED PCB
Dimm / Dali opsiyonu

Kullanım Alanları : Alışveriş merkezleri, Mağazalar, Ofisler

Specifications : Electrostatic anodized aluminum body
Highly permeable PMMA diffuser
Adjustable stainless-steel line hanging
Protection Class, IP44
High Efficiency LED Driver
High Luminosity LED PCB
Modular Emergency Kit
Dimm/Dali/RGB option

Usage : Shopping Malls, Stores, Offices



GM109L07

PCB LED

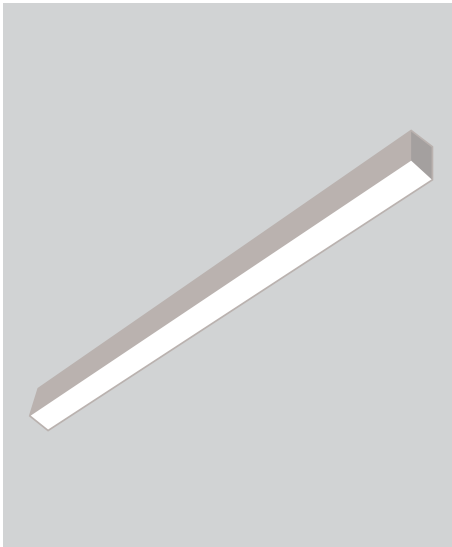
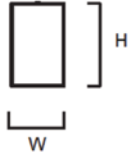

Led Tipi Led Type	Renk Isısı Color Temperature	Toplam Güç Total Power	Boyutlar Size	Voltaj Voltage	Toplam Lümen Total Lumen
PCB LED	3000/4000/6500K	9W	600/45/50mm	220V	720lm
PCB LED	3000/4000/6500K	15W	1000/45/50mm	220V	1200lm

Ürün Özellikleri : Elektrostatik toz boyalı alüminyum gövde
Yüksek geçirgenlikte PMMA difüzör
Ayarlanabilir çelik misina askı sistemi
Koruma sınıfı, IP44
Yüksek verimliliğe sahip LED sürücü
Işıl iletkenliği yüksek LED PCB
Dimm / Dali opsiyonu

Kullanım Alanları : Alışveriş merkezleri, Mağazalar, Ofisler

Specifications : Electrostatic anodized aluminum body
Highly permeable PMMA diffuser
Adjustable stainless-steel line hanging
Protection Class, IP44
High Efficiency LED Driver
High Luminosity LED PCB
Modular Emergency Kit
Dimm/Dali/RGB option

Usage : Shopping Malls, Stores, Offices



GM109L08

PCB LED



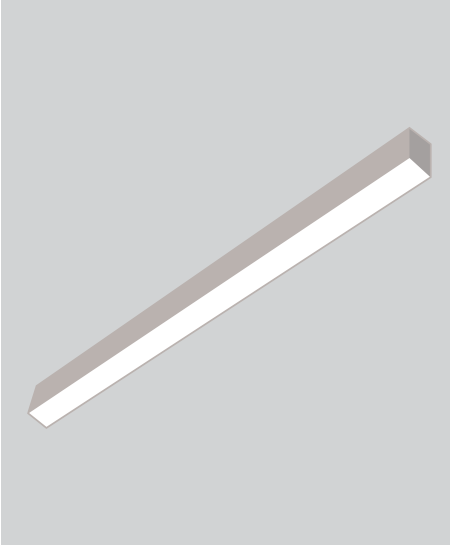

Led Tipi Led Type	Renk Isısı Color Temperature	Toplam Güç Total Power	Boyutlar Size	Voltaj Voltage	Toplam Lümen Total Lumen
PCB LED	3000/4000/6500K	15W	600/66/85mm	220V	1320lm
PCB LED	3000/4000/6500K	24W	1000/66/85mm	220V	2200lm
PCB LED	3000/4000/6500K	29W	1200/66/85mm	220V	2650lm
PCB LED	3000/4000/6500K	36W	1500/66/85mm	220V	3300lm

Ürün Özellikleri : Elektrostatik toz boyalı alüminyum gövde
Yüksek geçirgenlikte PMMA difüzör
Ayarlanabilir çelik misina askı sistemi
Koruma sınıfı, IP44
Yüksek verimliliğe sahip LED sürücü
Işıl iletkenliği yüksek LED PCB
Dimm / Dali opsiyonu

Kullanım Alanları : Alışveriş merkezleri, Mağazalar, Ofisler

Specifications : Electrostatic anodized aluminum body
Highly permeable PMMA diffuser
Adjustable stainless-steel line hanging
Protection Class, IP44
High Efficiency LED Driver
High Luminosity LED PCB
Modular Emergency Kit, Dimm/Dali/RGB option

Usage : Shopping Malls, Stores, Offices



GM109L09

PCB LED



Led Tipi Led Type	Renk Isısı Color Temperature	Toplam Güç Total Power	Boyutlar Size	Voltaj Voltage	Toplam Lümen Total Lumen
SMD LED	3000/4000/6500K	35W	600/600/75mm	220V	3390lm
SMD LED	3000/4000/6500K	15W	305/305/60mm	220V	1515lm

Ürün Özellikleri : Elektrostatik toz boyalı metal gövde
Yüksek geçirgenlikte PMMA opal difüzör
Koruma sınıfı, IP40
Yüksek verimliliğe sahip LED sürücü
Işıl iletkenliği yüksek SMD LED

Kullanım Alanları : Ofis, Eğitim alanları, Hastane, Mağazalar

Specifications : Electrostatic anodized metal body
Highly permeable PMMA diffuser
Protection Class, IP40
High Efficiency LED Driver
High Luminosity SMD LED

Usage : Offices, Schools, Hospitals, Stores

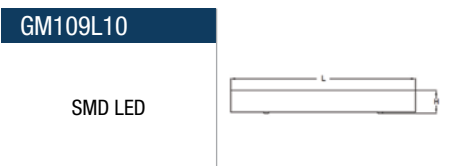

GM109L10

SMD LED



Led Tipi Led Type	Renk Isısı Color Temperature	Toplam Güç Total Power	Boyutlar Size	Voltaj Voltage	Toplam Lümen Total Lumen
SMD LED	3000/4000/6500K	8W	95/80mm	220V	720lm
SMD LED	3000/4000/6500K	12W	127/80mm	220V	1116lm
SMD LED	3000/4000/6500K	18W	180/80mm	220V	1710lm
SMD LED	3000/4000/6500K	23W	230/80mm	220V	2230lm

Ürün Özellikleri : Elektrostatik toz boyalı alüminyum gövde
Yüksek geçirgenlikli PMMA opal difüzör
Koruma sınıfı, IP20
Yüksek verimliliğe sahip LED sürücü
Işıl iletkenliği yüksek SMD LED

Kullanım Alanları : Ofis, Eğitim alanları, Hastane, Mağazalar

Specifications : Electrostatic anodized aluminum body
Highly permeable PMMA diffusor
Protection Class, IP20
High Efficiency LED Driver
High Luminosity SMD LED

Usage : Offices, Schools, Hospitals, Stores

GM109L11

SMD LED



Led Tipi Led Type	Renk Isısı Color Temperature	Toplam Güç Total Power	Boyutlar Size	Voltaj Voltage	Duy Socket
GU10 LED	2700/3000K	5.4W	70X70/80mm	220V	GU10

Ürün Özellikleri : Elektrostatik toz boyalı alüminyum gövde
Koruma sınıfı, IP20

Kullanım Alanları : Mağazalar, EV ve Ofisler

Specifications : Electrostatic anodized aluminum body
Protection Class: IP20

Usage : Stores, Homes, Offices

GM109L12

GU10 LED

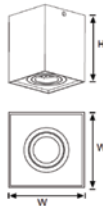



Led Tipi Led Type	Renk Isısı Color Temperature	Toplam Güç Total Power	Boyutlar Size	Voltaj Voltage	Duy Socket
GU10 LED	2700/3000K	5.4W	80/90mm	220V	GU10
GU10 LED	2700/3000K	14W	125/125mm	220V	PAR30

GM109L13

GU10 LED



Ürün Özellikleri : Elektrostatik toz boyalı alüminyum gövde
Koruma sınıfı, IP20

Kullanım Alanları : Mağazalar, EV ve Ofisler

Specifications : Electrostatic anodized aluminum body
Protection Class: IP20

Usage : Stores, Homes, Offices



Led Tipi Led Type	Renk Isısı Color Temperature	Toplam Güç Total Power	Boyutlar Size	Voltaj Voltage	Duy Socket
GU10 LED	2700/3000K	5.4W	100X100/140mm	220V	GU10

GM109L14

GU10 LED

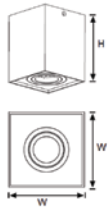

Ürün Özellikleri : Elektrostatik toz boyalı alüminyum gövde
Koruma sınıfı, IP20

Kullanım Alanları : Mağazalar, EV ve Ofisler

Specifications : Electrostatic anodized aluminum body
Protection Class: IP20

Usage : Stores, Homes, Offices



Led Tipi Led Type	Renk Isısı Color Temperature	Toplam Güç Total Power	Boyutlar Size	Voltaj Voltage	Duy Socket
GU10 LED	2700/3000K	5.4W	100/140mm	220V	GU10

GM109L15

GU10 LED



Ürün Özellikleri : Elektrostatik toz boyalı alüminyum gövde
Koruma sınıfı, IP20

Kullanım Alanları : Mağazalar, EV ve Ofisler

Specifications : Electrostatic anodized aluminum body
Protection Class: IP20

Usage : Stores, Homes, Offices



Led Tipi Led Type	Renk Isısı Color Temperature	Toplam Güç Total Power	Boyutlar Size	Voltaj Voltage	Duy Socket
GU10 LED	2700/3000K	1X5W	100X100/120mm	220V	GU10
GU10 LED	2700/3000K	2X5W	100X185/120mm	220V	GU10

GM109L16

GU10 LED

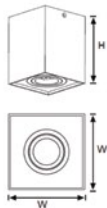

Ürün Özellikleri : Elektrostatik toz boyalı metal gövde
Koruma sınıfı, IP20

Kullanım Alanları : Alışveriş merkezleri, Mağazalar, Ofisler

Specifications : Electrostatic anodized metal body
Protection Class, IP20
High Luminosity GU10 LED Bulb

Usage : Shopping Malls, Stores, Offices

GM109L17

GU10 LED

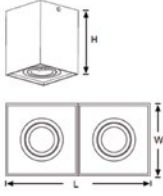

Led Tipi Led Type	Renk Isısı Color Temperature	Toplam Güç Total Power	Boyutlar Size	Voltaj Voltage	Duy Socket
GU10 LED	2700/3000K	1X5W	90/90/120mm	220V	GU10
GU10 LED	2700/3000K	2X5W	90/180X120mm	220V	GU10

- Ürün Özellikleri** : Elektrostatik toz boyalı metal gövde
Koruma sınıfı, IP20
Işıl iletkenliği yüksek GU10 Led Ampul
- Kullanım Alanları** : Alışveriş merkezleri, Mağazalar, Ofisler
- Specifications** : Electrostatic anodized metal body
Protection Class, IP20
High Luminosity GU10 LED Bulb
- Usage** : Shopping Malls, Stores, Offices

GM300L18

COB LED

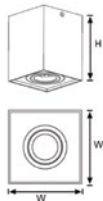

Led Tipi Led Type	Renk Isısı Color Temperature	Toplam Güç Total Power	Boyutlar Size	Voltaj Voltage	Toplam Lümen Total Lumen
COB LED 24°	3000/4000K	1X20	150X150/180mm	220V	2000lm
COB LED 42°	3000/4000K	1X30	150X150/180mm	220V	3000lm

- Ürün Özellikleri** : Elektrostatik toz boyalı metal gövde
Yüksek saflıkta alüminyum 24D 42° açılı Reflektör
Koruma sınıfı, IP20
Yüksek verimliliğe sahip LED sürücü
Işıl iletkenliği yüksek COB LED
- Kullanım Alanları** : Alışveriş merkezleri, Mağazalar, Ofisler
- Specifications** : Electrostatic anodized metal body
Highly pure aluminium 24D 42D angled reflector
Protection Class: IP20
High Efficiency LED Driver
High Luminosity COB LED
- Usage** : Shopping Malls, Stores, Offices



Led Tipi Led Type	Renk Isısı Color Temperature	Toplam Güç Total Power	Boyutlar Size	Voltaj Voltage	Toplam Lümen Total Lumen
PCB LED	3000/4000/6500K	22W	1200/37/46mm	220V	2240lm
PCB LED	3000/4000/6500K	28W	1500/37/46mm	220V	2870lm
PCB LED	3000/4000/6500K	15W	1000/18/16mm	220V	1200lm

Ürün Özellikleri : Elektrostatik toz boyalı alüminyum gövde
Yüksek geçirgenlikte PMMA difüzör
Koruma sınıfı, IP44
Yüksek verimliliğe sahip LED sürücü
Işıl iletkenliği yüksek PCB LED

Kullanım Alanları : Alışveriş merkezleri, Otoparklar, Depolar, Mağazalar, Ofisler

Specifications : Electrostatic anodized aluminum body
Highly permeable PMMA diffusor
Protection Class, IP44
High Efficiency LED Driver
High Luminosity LED PCB

Usage : Shopping Malls, Car Parks, Stores, Offices



GM300L19

PCB LED



Led Tipi Led Type	Renk Isısı Color Temperature	Toplam Güç Total Power	Boyutlar Size	Voltaj Voltage	Toplam Lümen Total Lumen
COB LED	3000/4000/6500K	11W	100/116mm	220V	735lm

Ürün Özellikleri : Elektrostatik toz boyalı alüminyum gövde
Koruma sınıfı, IP65
Yüksek ısıya dayanıklı cam
Yüksek verimliliğe sahip LED sürücü
Işıl iletkenliği yüksek COB LED

Kullanım Alanları : Park, Bahçe, Bina

Specifications : Electrostatic anodized aluminum body
Protection Class, IP65
Heat resistant Tempered glass
high efficiency LED Driver
High Luminosity COB LED

Usage : Parks, Gardens, Buildings



GM300L20

COB LED



Led Tipi Led Type	Renk Isısı Color Temperature	Toplam Güç Total Power	Boyutlar Size	Voltaj Voltage	Toplam Lümen Total Lumen
PCB LED	3000/4000/6500K	60W	1200/100/100mm	220V	5280lm
PCB LED	3000/4000/6500K	72W	1200/300/100mm	220V	6600lm

Ürün Özellikleri : Elektrostatik toz boyalı metal gövde
Yüksek geçirgenlikte PMMA difüzör
Ayarlanabilir çelik misina askı sistemi
Koruma sınıfı, IP20
Yüksek verimliliğe sahip LED sürücü
Işıl iletkenliği yüksek LED PCB
Acil aydınlatma kiti ilave edebilme
Dimm / Dali opsiyonu

Kullanım Alanları : Alışveriş merkezleri, Mağazalar, Ofisler

Specifications : Electrostatic anodized metal body
Highly permeable PMMA diffuser
Adjustable stainless-steel line hanging
Protection Class, IP20
High Efficiency LED Driver
High Luminosity LED PCB
Modular Emergency Kit
Dimm/Dali/RGB option

Usage : Shopping Malls, Stores, Offices

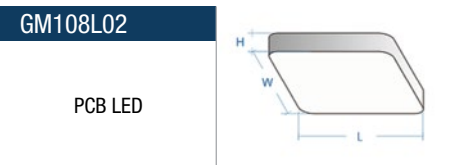

Led Tipi Led Type	Renk Isısı Color Temperature	Toplam Güç Total Power	Boyutlar Size	Voltaj Voltage	Toplam Lümen Total Lumen
PCB LED	3000/4000/6500K	36W	300/300/100mm	220V	3300lm
PCB LED	3000/4000/6500K	67W	600/600/100mm	220V	6200lm
PCB LED	3000/4000/6500K	100W	900/900/100mm	220V	9300lm

Ürün Özellikleri : Elektrostatik toz boyalı alüminyum gövde
Yüksek geçirgenlikte PMMA difüzör
Ayarlanabilir çelik misina askı sistemi
Koruma sınıfı, IP20
Yüksek verimliliğe sahip LED sürücü
Işıl iletkenliği yüksek LED PCB
Acil aydınlatma kiti ilave edebilme
Dimm / Dali opsiyonu

Kullanım Alanları : Alışveriş merkezleri, Mağazalar, Ofisler

Specifications : Electrostatic anodized aluminium body
Highly permeable PMMA diffuser
Adjustable stainless-steel line hanging
Protection Class, IP20
High Efficiency LED Driver
High Luminosity LED PCB
Modular Emergency Kit
Dimm/Dali/RGB option

Usage : Shopping Malls, Stores, Offices

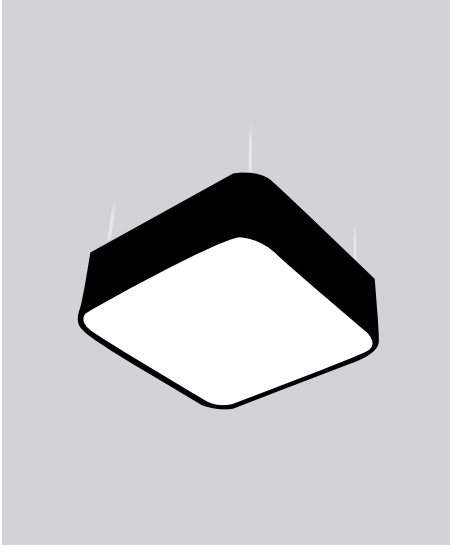

Led Tipi Led Type	Renk Isısı Color Temperature	Toplam Güç Total Power	Boyutlar Size	Voltaj Voltage	Toplam Lümen Total Lumen
PCB LED	3000/4000/6500K	36W	300/300/100mm	220V	3300lm
PCB LED	3000/4000/6500K	67W	600/600/100mm	220V	6200lm
PCB LED	3000/4000/6500K	100W	900/900/100mm	220V	9300lm

Ürün Özellikleri : Elektrostatik toz boyalı alüminyum gövde
Yüksek geçirgenlikte PMMA difüzör
Ayarlanabilir çelik misina askı sistemi
Koruma sınıfı, IP20
Yüksek verimliliğe sahip LED sürücü
Işıl iletkenliği yüksek LED PCB
Acil aydınlatma kiti ilave edebilme
Dimm / Dali opsiyonu

Kullanım Alanları : Alışveriş merkezleri, Mağazalar, Ofisler

Specifications : Electrostatic anodized aluminium body
Highly permeable PMMA diffusor
Adjustable stainless-steel line hanging
Protection Class, IP20
High Efficiency LED Driver
High Luminosity LED PCB
Modular Emergency Kit
Dimm/Dali/RGB option

Usage : Shopping Malls, Stores, Offices

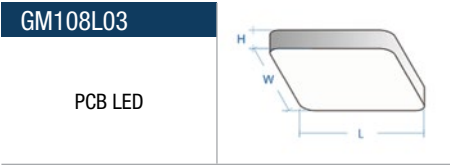

GM108L03

PCB LED

Led Tipi Led Type	Renk Isısı Color Temperature	Toplam Güç Total Power	Boyutlar Size	Voltaj Voltage	Toplam Lümen Total Lumen
PCB LED	3000/4000/6500K	30W	400/80/100mm	220V	2700lm
PCB LED	3000/4000/6500K	45W	600/80/100mm	220V	4100lm
PCB LED	3000/4000/6500K	60W	800/80/100mm	220V	5500lm
PCB LED	3000/4000/6500K	75W	1000/80/100mm	220V	6900lm
PCB LED	3000/4000/6500K	90W	1200/80/100mm	220V	8300lm
PCB LED	3000/4000/6500K	110W	1500/80/100mm	220V	10300lm

Ürün Özellikleri : Elektrostatik toz boyalı alüminyum gövde
Yüksek geçirgenlikte PMMA difüzör
Ayarlanabilir çelik misina askı sistemi
Koruma sınıfı, IP20
Yüksek verimliliğe sahip LED sürücü
Işıl iletkenliği yüksek LED PCB
Acil aydınlatma kiti ilave edebilme, Dimm / Dali opsiyonu

Kullanım Alanları : Alışveriş merkezleri, Mağazalar, Ofisler

Specifications : Electrostatic anodized aluminium body
Highly permeable PMMA diffusor
Adjustable stainless-steel line hanging
Protection Class, IP20
High Efficiency LED Driver
High Luminosity LED PCB
Modular Emergency Kit, Dimm/Dali/RGB option

Usage : Shopping Malls, Stores, Offices

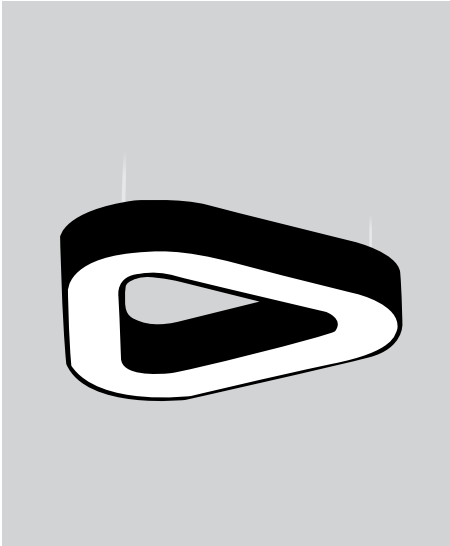

GM108L04

PCB LED



Led Tipi Led Type	Renk Isısı Color Temperature	Toplam Güç Total Power	Boyutlar Size	Voltaj Voltage	Toplam Lümen Total Lumen
PCB LED	3000/4000/6500K	30W	600/100/100mm	220V	2700lm
PCB LED	3000/4000/6500K	45W	900/100/100mm	220V	4100lm
PCB LED	3000/4000/6500K	60W	1200/100/100mm	220V	5500lm
PCB LED	3000/4000/6500K	75W	1500/100/100mm	220V	6900lm

Ürün Özellikleri : Elektrostatik toz boyalı alüminyum gövde
Yüksek geçirgenlikte PMMA difüzör
Ayarlanabilir çelik misina askı sistemi
Koruma sınıfı, IP20
Yüksek verimliliğe sahip LED sürücü
Işıl iletkenliği yüksek LED PCB
Acil aydınlatma kiti ilave edebilme, Dimm / Dali opsiyonu

Kullanım Alanları : Alışveriş merkezleri, Mağazalar, Ofisler

Specifications : Electrostatic anodized aluminium body
Highly permeable PMMA diffusor
Adjustable stainless-steel line hanging
Protection Class, IP20
High Efficiency LED Driver
High Luminosity LED PCB
Modular Emergency Kit, Dimm/Dali/RGB option

Usage : Shopping Malls, Stores, Offices



GM108L05

PCB LED



Led Tipi Led Type	Renk Isısı Color Temperature	Toplam Güç Total Power	Boyutlar Size	Voltaj Voltage	Toplam Lümen Total Lumen
PCB LED	3000/4000/6500K	30W	400/80/100mm	220V	2700lm
PCB LED	3000/4000/6500K	45W	600/80/100mm	220V	4100lm
PCB LED	3000/4000/6500K	60W	800/80/100mm	220V	5500lm
PCB LED	3000/4000/6500K	75W	1000/80/100mm	220V	6900lm
PCB LED	3000/4000/6500K	90W	1200/80/100mm	220V	8300lm
PCB LED	3000/4000/6500K	110W	1500/80/100mm	220V	10300lm

Ürün Özellikleri : Elektrostatik toz boyalı alüminyum gövde
Yüksek geçirgenlikte PMMA difüzör
Ayarlanabilir çelik misina askı sistemi
Koruma sınıfı, IP20
Yüksek verimliliğe sahip LED sürücü
Işıl iletkenliği yüksek LED PCB
Acil aydınlatma kiti ilave edebilme, Dimm / Dali opsiyonu

Kullanım Alanları : Alışveriş merkezleri, Mağazalar, Ofisler

Specifications : Electrostatic anodized aluminium body
Highly permeable PMMA diffusor
Adjustable stainless-steel line hanging
Protection Class, IP20
High Efficiency LED Driver
High Luminosity LED PCB
Modular Emergency Kit, Dimm/Dali/RGB option

Usage : Shopping Malls, Stores, Offices

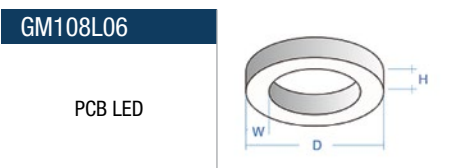

GM108L06

PCB LED

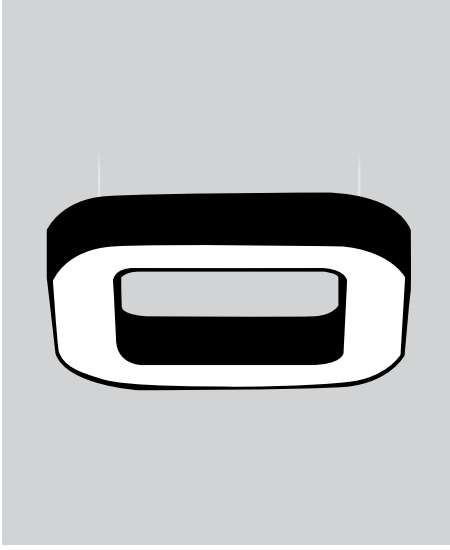

Led Tipi Led Type	Renk Isısı Color Temperature	Toplam Güç Total Power	Boyutlar Size	Voltaj Voltage	Toplam Lümen Total Lumen
PCB LED	3000/4000/6500K	38W	400/80/100mm	220V	3500lm
PCB LED	3000/4000/6500K	57W	600/80/100mm	220V	5200lm
PCB LED	3000/4000/6500K	76W	800/80/100mm	220V	7000lm
PCB LED	3000/4000/6500K	96W	1000/80/100mm	220V	8800lm
PCB LED	3000/4000/6500K	115W	1200/80/100mm	220V	10500lm
PCB LED	3000/4000/6500K	144W	1500/80/100mm	220V	13200lm

Ürün Özellikleri : Elektrostatik toz boyalı metal gövde
Yüksek geçirgenlikte PMMA difüzör
Ayarlanabilir çelik misina askı sistemi
Koruma sınıfı, IP20
Yüksek verimliliğe sahip LED sürücü
Işıl iletkenliği yüksek LED PCB
Acil aydınlatma kiti ilave edebilme, Dimm / Dali opsiyonu

Kullanım Alanları : Alışveriş merkezleri, Mağazalar, Ofisler

Specifications : Electrostatic anodized metal body
Highly permeable PMMA diffusor
Adjustable stainless-steel line hanging
Protection Class, IP20
High Efficiency LED Driver
High Luminosity LED PCB
Modular Emergency Kit, Dimm/Dali/RGB option

Usage : Shopping Malls, Stores, Offices

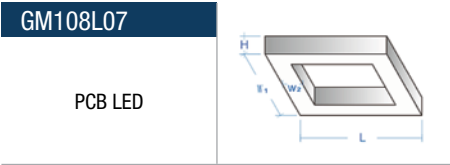

GM108L07

PCB LED



Led Tipi Led Type	Renk Isısı Color Temperature	Toplam Güç Total Power	Boyutlar Size	Voltaj Voltage	Toplam Lümen Total Lumen
PCB LED	3000/4000/6500K	15W	600/45/85mm	220V	1320lm
PCB LED	3000/4000/6500K	24W	1000/45/85mm	220V	2200lm
PCB LED	3000/4000/6500K	29W	1200/45/85mm	220V	2650lm
PCB LED	3000/4000/6500K	36W	1500/45/85mm	220V	3300lm

Ürün Özellikleri : Elektrostatik toz boyalı alüminyum gövde
Yüksek geçirgenlikte PMMA difüzör
Ayarlanabilir çelik misina askı sistemi
Koruma sınıfı, IP44
Yüksek verimliliğe sahip LED sürücü
Işıl iletkenliği yüksek LED PCB
Dimm / Dali opsiyonu

Kullanım Alanları : Alışveriş merkezleri, Mağazalar, Ofisler

Specifications : Electrostatic anodized aluminium body
Highly permeable PMMA diffusor
Adjustable stainless-steel line hanging
Protection Class, IP44
High Efficiency LED Driver
High Luminosity LED PCB
Dimm/Dali/RGB option

Usage : Shopping Malls, Stores, Offices



GM108L08

PCB LED



Led Tipi Led Type	Renk Isısı Color Temperature	Toplam Güç Total Power	Boyutlar Size	Voltaj Voltage	Toplam Lümen Total Lumen
PCB LED	3000/4000/6500K	40W	60/1210/1000mm	220V	4400lm

Ürün Özellikleri : Elektrostatik toz boyalı alüminyum gövde
Yüksek geçirgenlikte PMMA difüzör
Ayarlanabilir çelik misina askı sistemi
Koruma sınıfı, IP44
Yüksek verimliliğe sahip LED sürücü
Işıl iletkenliği yüksek LED PCB
Dimm / Dali / RGB opsiyonu

Kullanım Alanları : Alışveriş merkezleri, Mağazalar, Ofisler

Specifications : Electrostatic anodized aluminium body
Highly permeable PMMA diffusor
Adjustable stainless-steel line hanging
Protection Class, IP44
High Efficiency LED Driver
High Luminosity LED PCB
Dimm/Dali/RGB option

Usage : Shopping Malls, Stores, Offices

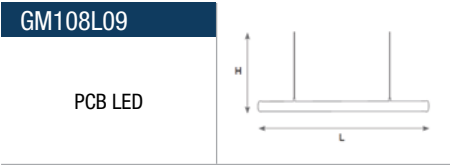

GM108L09

PCB LED



Led Tipi Led Type	Renk Isısı Color Temperature	Toplam Güç Total Power	Boyutlar Size	Voltaj Voltage	Toplam Lümen Total Lumen
COB LED 24°	3000/4000K	1X20	125/150mm	220V	2000lm
COB LED 42°	3000/4000K	1X30	125/150mm	220V	2000lm

Ürün Özellikleri : Elektrostatik toz boyalı alüminyum gövde
Yüksek saflıkta alüminyum 24° 42° açılı Reflektör
Koruma sınıfı, IP20
Yüksek verimliliğe sahip LED sürücü
Işıl iletkenliği yüksek COB LED

Kullanım Alanları : Alışveriş merkezleri, Mağazalar, Ofisler

Specifications : Electrostatic anodized aluminium body
Highly pure aluminium 24° 42° angled reflector
Protection Class, IP20
High Efficiency LED Driver
High Luminosity COB LED

Usage : Shopping Malls, Stores, Offices

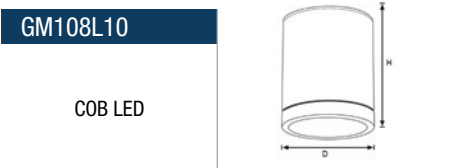

GM108L10

COB LED



GM108L11

PCB LED

Led Tipi Led Type	Renk Isısı Color Temperature	Toplam Güç Total Power	Boyutlar Size	Voltaj Voltage	Toplam Lümen Total Lumen
PCB LED	3000K	55W	350+500+650/20mm	220V	3850lm
PCB LED	3000K	68W	450+600+750/35mm	220V	4760lm
PCB LED	3000K	79W	550+700+850/35mm	220V	5530lm
PCB LED	3000K	91W	650+800+950/35mm	220V	6370lm

Ürün Özellikleri : Elektrostatik toz boyalı alüminyum gövde
Yüksek geçirgenlikte PMMA difüzör
Ayarlanabilir çelik misina askı sistemi
Koruma sınıfı, IP20
Yüksek verimliliğe sahip LED sürücü
Işıl iletkenliği yüksek LED PCB
Dimm / Dali / RGB opsiyonu

Kullanım Alanları : Alışveriş merkezleri, Mağazalar, Ofisler

Specifications : Electrostatic anodized aluminum body
Highly permeable PMMA diffuser
Adjustable stainless-steel line hanging
Protection Class: IP20
High Efficiency LED Driver
High Luminosity LED PCB
Dimm/Dali/RGB option

Usage : Shopping Malls, Stores, Offices

Led Tipi Led Type	Renk Isısı Color Temperature	Toplam Güç Total Power	Boyutlar Size	Voltaj Voltage	Toplam Lümen Total Lumen
PCB LED	3000K	25W	120mm	220V	2500lm



GM108L12

PCB LED

Ürün Özellikleri : Elektrostatik toz boyalı alüminyum gövde
Ayarlanabilir çelik misina askı sistemi
Koruma sınıfı, IP20
Yüksek verimliliğe sahip LED sürücü
Işıl iletkenliği yüksek LED PCB
Dimm / Dali / RGB opsiyonu

Kullanım Alanları : Alışveriş merkezleri, Mağazalar, Ofisler

Specifications : Electrostatic anodized aluminum body
Adjustable stainless-steel line hanging
Protection Class: IP20
High Efficiency LED Driver
High Luminosity LED PCB
Dimm/Dali/RGB option

Usage : Shopping Malls, Stores, Offices



Led Tipi Led Type	Renk Isısı Color Temperature	Toplam Güç Total Power	Boyutlar Size	Voltaj Voltage	Toplam Lümen Total Lumen
PCB LED	3000/4000/6500K	28W	600/80/80mm	220V	850lm
PCB LED	3000/4000/6500K	38W	800/80/80mm	220V	1150lm
PCB LED	3000/4000/6500K	48W	1000/80/80mm	220V	1450lm

Ürün Özellikleri : Elektrostatik toz boyalı alüminyum gövde
Yüksek geçirgenlikte PMMA difüzör
Ayarlanabilir çelik misina askı sistemi
Koruma sınıfı, IP20
Yüksek verimliliğe sahip LED sürücü
Işıl iletkenliği yüksek LED PCB
Dimm / Dali / RGB opsiyonu

Kullanım Alanları : Alışveriş merkezleri, Mağazalar, Ofisler

Specifications : Electrostatic anodized aluminum body
Highly permeable PMMA diffuser
Adjustable stainless-steel line hanging
Protection Class, IP20
High Efficiency LED Driver
High Luminosity LED PCB
Dimm/Dali/RGB option

Usage : Shopping Malls, Stores, Offices

GM108L13

PCB LED

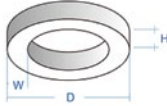

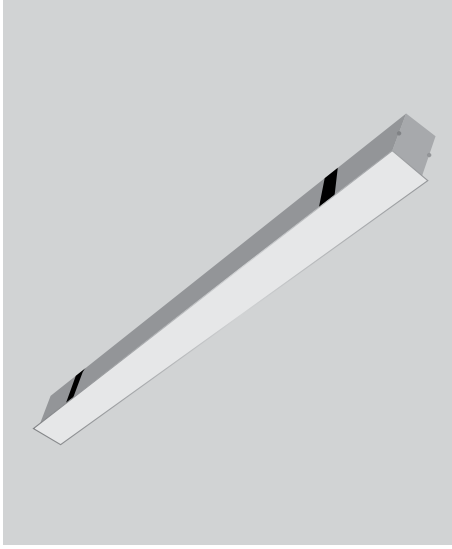

Led Tipi Led Type	Renk Isısı Color Temperature	Toplam Güç Total Power	Boyutlar Size	Voltaj Voltage	Toplam Lümen Total Lumen
PCB LED	3000/4000/6500K	18W	600/112/85/95X583mm	220V	1450lm
PCB LED	3000/4000/6500K	29W	1000/112/85/95X983mm	220V	2400lm
PCB LED	3000/4000/6500K	35W	1200/112/85/95X1183mm	220V	2900lm
PCB LED	3000/4000/6500K	44W	1500/112/85/95X1483mm	220V	3600lm

Ürün Özellikleri : Elektrostatik toz boyalı alüminyum gövde
Yüksek geçirgenlikte PMMA difüzör
Koruma sınıfı, IP44
Yüksek verimliliğe sahip LED sürücü
Işıl iletkenliği yüksek LED PCB
Dimm / Dali opsiyonu

Kullanım Alanları : Alışveriş merkezleri, Mağazalar, Ofisler

Specifications : Electrostatic anodized aluminum body
Highly permeable PMMA diffusor
Protection Class: IP44
High Efficiency LED Driver
High Luminosity LED PCB
Dimm/Dali/RGB option

Usage : Shopping Malls, Stores, Offices

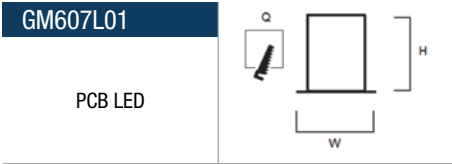

GM607L01

PCB LED

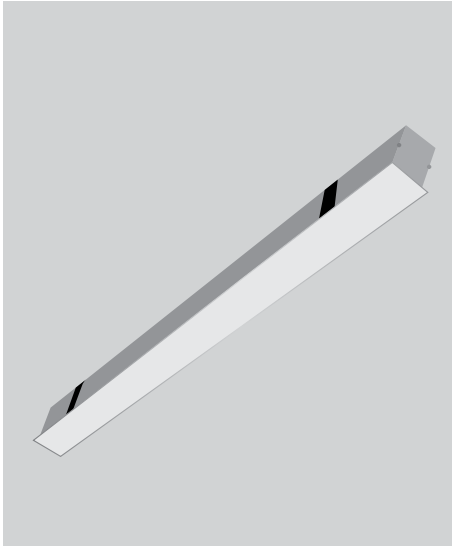

Led Tipi Led Type	Renk Isısı Color Temperature	Toplam Güç Total Power	Boyutlar Size	Voltaj Voltage	Toplam Lümen Total Lumen
PCB LED	3000/4000/6500K	18W	600/82/85/73X590mm	220V	1450lm
PCB LED	3000/4000/6500K	29W	1000/82/85/73X990mm	220V	2400lm
PCB LED	3000/4000/6500K	35W	1200/82/85/73X1110mm	220V	2900lm
PCB LED	3000/4000/6500K	44W	1500/82/85/73X1490mm	220V	3600lm

Ürün Özellikleri : Elektrostatik toz boyalı alüminyum gövde
Yüksek geçirgenlikte PMMA difüzör
Koruma sınıfı, IP44
Yüksek verimliliğe sahip LED sürücü
Işıl iletkenliği yüksek LED PCB
Dimm / Dali opsiyonu

Kullanım Alanları : Alışveriş merkezleri, Mağazalar, Ofisler

Specifications : Electrostatic anodized aluminum body
Highly permeable PMMA diffusor
Protection Class: IP44
High Efficiency LED Driver
High Luminosity LED PCB
Dimm/Dali/RGB option

Usage : Shopping Malls, Stores, Offices

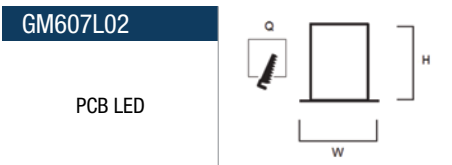

GM607L02

PCB LED



Led Tipi Led Type	Renk Isısı Color Temperature	Toplam Güç Total Power	Boyutlar Size	Voltaj Voltage	Toplam Lümen Total Lumen
PCB LED	3000/4000/6500K	15W	600/46/60/35X590mm	220V	1320lm
PCB LED	3000/4000/6500K	24W	1000/46/60/35X990mm	220V	2200lm
PCB LED	3000/4000/6500K	29W	1200/46/60/35X1110mm	220V	2650lm
PCB LED	3000/4000/6500K	36W	1500/46/60/35X1490mm	220V	3300lm

Ürün Özellikleri : Elektrostatik toz boyalı alüminyum gövde
Yüksek geçirgenlikte PMMA difüzör
Koruma sınıfı, IP44
Yüksek verimliliğe sahip LED sürücü
Işıl iletkenliği yüksek LED PCB
Dimm / Dalı opsiyonu

Kullanım Alanları : Alışveriş merkezleri, Mağazalar, Ofisler

Specifications : Electrostatic anodized aluminum body
Highly permeable PMMA diffusor
Protection Class: IP44
High Efficiency LED Driver
High Luminosity LED PCB
Dimm/Dali/RGB option

Usage : Shopping Malls, Stores, Offices

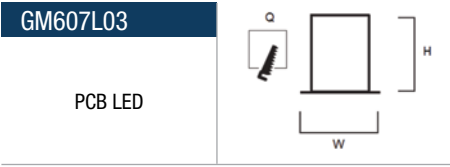

GM607L03

PCB LED



Led Tipi Led Type	Renk Isısı Color Temperature	Toplam Güç Total Power	Boyutlar Size	Voltaj Voltage	Toplam Lümen Total Lumen
SMD LED	3000/4000/6500K	35W	595X595/65/575X575mm	220V	3390lm
SMD LED	3000/4000/6500K	15W	297X297/45/275X275mm	220V	1515lm
SMD LED	3000/4000/6500K	35W	595X595/65/575X575mm	220V	3220lm
SMD LED	3000/4000/6500K	15W	297X297/45/275X275mm	220V	1440lm

Ürün Özellikleri : Elektrostatik toz boyalı alüminyum gövde
Yüksek geçirgenlikte PMMA difüzör
Koruma sınıfı, IP40
Yüksek verimliliğe sahip LED sürücü
Işıl iletkenliği yüksek SMD LED

Kullanım Alanları : Ofis, Eğitim alanları, Hastane, Mağazalar

Specifications : Electrostatic anodized aluminum body
Highly permeable PMMA diffusor
Protection Class, IP40
High Efficiency LED Driver
High Luminosity SMD LED

Usage : Offices, Schools, Hospitals, Stores

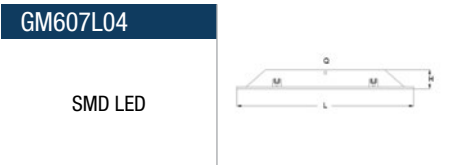

GM607L04

SMD LED

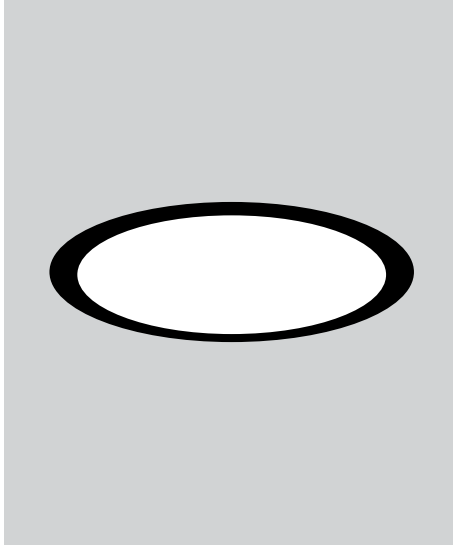

Led Tipi Led Type	Renk Isısı Color Temperature	Toplam Güç Total Power	Boyutlar Size	Voltaj Voltage	Toplam Lümen Total Lumen
PCB LED	3000/4000/6500K	60W	400/100/380mm	220V	5500lm
PCB LED	3000/4000/6500K	90W	600/100/580mm	220V	8300lm
PCB LED	3000/4000/6500K	120W	800/100/780mm	220V	11000lm
PCB LED	3000/4000/6500K	150W	1000/100/980mm	220V	13800lm
PCB LED	3000/4000/6500K	180W	1200/100/1180mm	220V	16500lm
PCB LED	3000/4000/6500K	220W	1500/100/1480mm	220V	20700lm

Ürün Özellikleri : Elektrostatik toz boyalı alüminyum gövde
Yüksek geçirgenlikte PMMA difüzör
Koruma sınıfı, IP20
Yüksek verimliliğe sahip LED sürücü
Işıl iletkenliği yüksek LED PCB
Acil aydınlatma kiti ilave edebilme
Dimm / Dali opsiyonu

Kullanım Alanları : Alışveriş merkezleri, Mağazalar, Ofisler

Specifications : Electrostatic anodized aluminum body
Highly permeable PMMA diffusor
Protection Class: IP20
High Efficiency LED Driver
High Luminosity LED PCB
Modular Emergency Kit
Dimm/Dali/RGB option

Usage : Shopping Malls, Stores, Offices

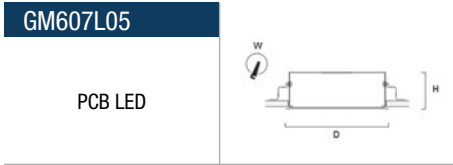

GM607L05

PCB LED

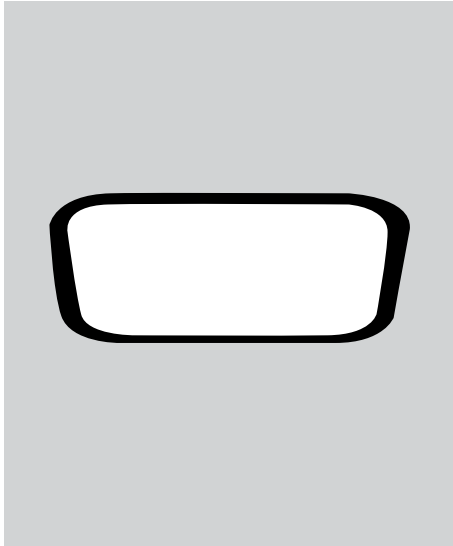

Led Tipi Led Type	Renk Isısı Color Temperature	Toplam Güç Total Power	Boyutlar Size	Voltaj Voltage	Toplam Lümen Total Lumen
PCB LED	3000/4000/6500K	36W	300/100/280mm	220V	3300lm
PCB LED	3000/4000/6500K	67W	600/100/580mm	220V	6200lm
PCB LED	3000/4000/6500K	100W	900/100/880mm	220V	9300lm

Ürün Özellikleri : Elektrostatik toz boyalı alüminyum gövde
Yüksek geçirgenlikte PMMA difüzör
Koruma sınıfı, IP20
Yüksek verimliliğe sahip LED sürücü
Işıl iletkenliği yüksek LED PCB
Acil aydınlatma kiti ilave edebilme
Dimm / Dali opsiyonu

Kullanım Alanları : Alışveriş merkezleri, Mağazalar, Ofisler

Specifications : Electrostatic anodized aluminum body
Highly permeable PMMA diffusor
Protection Class: IP20
High Efficiency LED Driver
High Luminosity LED PCB
Modular Emergency Kit
Dimm/Dali/RGB option

Usage : Shopping Malls, Stores, Offices

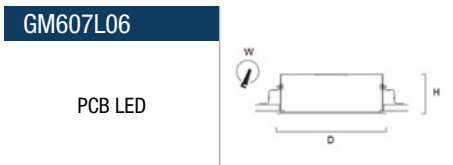

GM607L06

PCB LED



Led Tipi Led Type	Renk Isısı Color Temperature	Toplam Güç Total Power	Boyutlar Size	Voltaj Voltage	Toplam Lümen Total Lumen
PCB LED	3000/4000/6500K	30W	600/100/100mm	220V	2700lm
PCB LED	3000/4000/6500K	45W	900/100/100mm	220V	4100lm
PCB LED	3000/4000/6500K	60W	1200/100/100mm	220V	5500lm
PCB LED	3000/4000/6500K	75W	1500/100/100mm	220V	6900lm

Ürün Özellikleri : Elektrostatik toz boyalı alüminyum gövde
Yüksek geçirgenlikte PMMA difüzör
Koruma sınıfı, IP20
Yüksek verimliliğe sahip LED sürücü
Işıl iletkenliği yüksek LED PCB
Acil aydınlatma kiti ilave edebilme
Dimm / Dali opsiyonu

Kullanım Alanları : Alışveriş merkezleri, Mağazalar, Ofisler

Specifications : Electrostatic anodized aluminum body
Highly permeable PMMA diffusor
Protection Class: IP20
High Efficiency LED Driver
High Luminosity LED PCB
Modular Emergency Kit
Dimm/Dali/RGB option

Usage : Shopping Malls, Stores, Offices



GM607L07

PCB LED



Led Tipi Led Type	Renk Isısı Color Temperature	Toplam Güç Total Power	Boyutlar Size	Voltaj Voltage	Toplam Lümen Total Lumen
COB LED 24°	3000/4000K	20W	190/150/175mm	220V	2000lm
COB LED 42°	3000/4000K	30W	190/150/175mm	220V	3000lm

Ürün Özellikleri : Elektrostatik toz boyalı alüminyum gövde
Yüksek saflıkta alüminyum 24° 42° açılı Reflektör
Koruma sınıfı, IP20
Yüksek verimliliğe sahip LED sürücü
Işıl iletkenliği yüksek COB LED

Kullanım Alanları : Alışveriş merkezleri, Mağazalar, Ofisler

Specifications : Electrostatic anodized aluminum body
Highly pure aluminium 24° 42° angled reflector
Protection Class, IP20
High Efficiency LED Driver
High Luminosity COB LED

Usage : Shopping Malls, Stores, Offices



GM607L08

COB LED



Led Tipi Led Type	Renk Isısı Color Temperature	Toplam Güç Total Power	Boyutlar Size	Voltaj Voltage	Toplam Lümen Total Lumen
COB LED 24°	3000/4000K	20W	190/100/175mm	220V	2000lm
COB LED 42°	3000/4000K	30W	190/100/175mm	220V	3000lm

Ürün Özellikleri : Elektrostatik toz boyalı alüminyum gövde
Yüksek saflıkta alüminyum 24° 42° açılı Reflektör
Koruma sınıfı, IP20
Yüksek verimliliğe sahip LED sürücü
Işıl iletkenliği yüksek COB LED

Kullanım Alanları : Alışveriş merkezleri, Mağazalar, Ofisler

Specifications : Electrostatic anodized aluminum body
Highly pure aluminium 24° 42° angled reflector
Protection Class, IP20
High Efficiency LED Driver
High Luminosity COB LED

Usage : Shopping Malls, Stores, Offices

GM607L09

COB LED

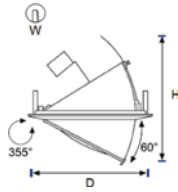

Led Tipi Led Type	Renk Isısı Color Temperature	Toplam Güç Total Power	Boyutlar Size	Voltaj Voltage	Toplam Lümen Total Lumen
COB LED 24°	3000/4000K	20W	190/150/175mm	220V	2000lm
COB LED 42°	3000/4000K	30W	190/150/175mm	220V	3000lm

Ürün Özellikleri : Elektrostatik toz boyalı alüminyum gövde
Yüksek saflıkta alüminyum 24° 42° açılı Reflektör
Koruma sınıfı, IP20
Yüksek verimliliğe sahip LED sürücü
Işıl iletkenliği yüksek COB LED

Kullanım Alanları : Alışveriş merkezleri, Mağazalar, Ofisler

Specifications : Electrostatic anodized aluminum body
Highly pure aluminium 24° 42° angled reflector
Protection Class, IP20
High Efficiency LED Driver
High Luminosity COB LED

Usage : Shopping Malls, Stores, Offices

GM607L10

COB LED

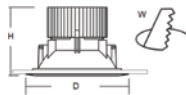



GM607L11

COB LED

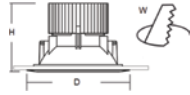

Led Tipi Led Type	Renk Isısı Color Temperature	Toplam Güç Total Power	Boyutlar Size	Voltaj Voltage	Toplam Lümen Total Lumen
COB LED 24°	3000/4000K	1X20W	190X190/150/170X170mm	220V	2000lm
COB LED 42°	3000/4000K	1X30W	190X190/150/170X170mm	220V	3000lm
COB LED 24°	3000/4000K	2X20W	190X340/150/170X320mm	220V	2000lm
COB LED 42°	3000/4000K	2X30W	190X340/150/170X320mm	220V	3000lm

Ürün Özellikleri : Elektrostatik toz boyalı alüminyum gövde
Yüksek saflıkta alüminyum 24° 42° açılı Reflektör
Koruma sınıfı, IP20
Yüksek verimliliğe sahip LED sürücü
Işıl iletkenliği yüksek COB LED

Kullanım Alanları : Alışveriş merkezleri, Mağazalar, Ofisler

Specifications : Electrostatic anodized aluminum body
Highly pure aluminium 24° 42° angled reflector
Protection Class, IP20
High Efficiency LED Driver
High Luminosity COB LED

Usage : Shopping Malls, Stores, Offices



GM607L12

COB LED

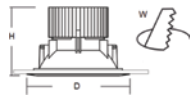

Led Tipi Led Type	Renk Isısı Color Temperature	Toplam Güç Total Power	Boyutlar Size	Voltaj Voltage	Toplam Lümen Total Lumen
COB LED 24°	3000/4000K	1X20W	190X190/150/170X170mm	220V	2000lm
COB LED 42°	3000/4000K	1X30W	190X190/150/170X170mm	220V	3000lm
COB LED 24°	3000/4000K	2X20W	190X340/150/170X320mm	220V	2000lm
COB LED 42°	3000/4000K	2X30W	190X340/150/170X320mm	220V	3000lm

Ürün Özellikleri : Elektrostatik toz boyalı alüminyum gövde
Yüksek saflıkta alüminyum 24° 42° açılı Reflektör
Koruma sınıfı, IP20
Yüksek verimliliğe sahip LED sürücü
Işıl iletkenliği yüksek COB LED

Kullanım Alanları : Alışveriş merkezleri, Mağazalar, Ofisler

Specifications : Electrostatic anodized aluminum body
Highly pure aluminium 24° 42° angled reflector
Protection Class, IP20
High Efficiency LED Driver
High Luminosity COB LED

Usage : Shopping Malls, Stores, Offices



Led Tipi Led Type	Renk Isısı Color Temperature	Toplam Güç Total Power	Boyutlar Size	Voltaj Voltage	Toplam Lümen Total Lumen
COB LED 24°	3000/4000K	1X20W	160X160/150/165X165mm	220V	2000lm
COB LED 42°	3000/4000K	1X30W	160X160/150/165X165mm	220V	3000lm
COB LED 24°	3000/4000K	2X20W	160X320/150/165X330mm	220V	2000lm
COB LED 42°	3000/4000K	2X30W	160X320/150/165X330mm	220V	3000lm

Ürün Özellikleri : Elektrostatik toz boyalı alüminyum gövde
Yüksek saflıkta alüminyum 24° 42° açılı Reflektör
Koruma sınıfı, IP20
Yüksek verimliliğe sahip LED sürücü
Işıl iletkenliği yüksek COB LED

Kullanım Alanları : Alışveriş merkezleri, Mağazalar, Ofisler

Specifications : Electrostatic anodized aluminum body
Highly pure aluminium 24° 42° angled reflector
Protection Class, IP20
High Efficiency LED Driver
High Luminosity COB LED

Usage : Shopping Malls, Stores, Offices

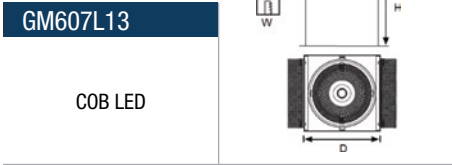

GM607L13

COB LED



Led Tipi Led Type	Renk Isısı Color Temperature	Toplam Güç Total Power	Boyutlar Size	Voltaj Voltage	Toplam Lümen Total Lumen
COB LED 24/42°	3000/4000K	30W	190/165/175mm	220V	3000lm

Ürün Özellikleri : Elektrostatik toz boyalı alüminyum gövde
Yüksek saflıkta alüminyum 24° 42° açılı Reflektör
Koruma sınıfı, IP20
Yüksek verimliliğe sahip LED sürücü
Işıl iletkenliği yüksek COB LED

Kullanım Alanları : Alışveriş merkezleri, Mağazalar, Ofisler

Specifications : Electrostatic anodized aluminum body
Highly pure aluminium 24° 42° angled reflector
Protection Class, IP20
High Efficiency LED Driver
High Luminosity COB LED

Usage : Shopping Malls, Stores, Offices

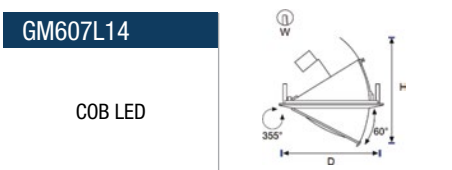

GM607L14

COB LED



Led Tipi Led Type	Renk Isısı Color Temperature	Toplam Güç Total Power	Boyutlar Size	Voltaj Voltage	Duy Socket
GU10 LED	2700/3000K	5.4W	100/85/85mm	220V	GU10

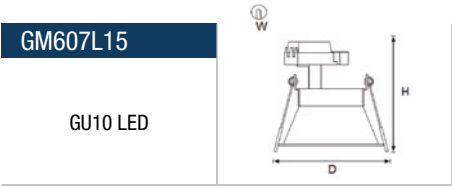

Ürün Özellikleri : Elektrostatik toz boyalı alüminyum gövde
Koruma sınıfı, IP20
Kullanım Alanları : Mağazalar, Ev ve Ofisler
Specifications : Electrostatic anodized aluminum body
Protection Class: IP20
Usage : Stores, Homes, Offices.



Led Tipi Led Type	Renk Isısı Color Temperature	Toplam Güç Total Power	Boyutlar Size	Voltaj Voltage	Duy Socket
GU10 LED	2700/3000K	5.4W	100/85/90mm	220V	GU10

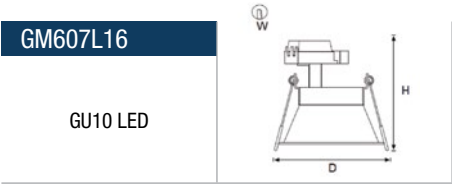

Ürün Özellikleri : Elektrostatik toz boyalı alüminyum gövde
Koruma sınıfı, IP20
Kullanım Alanları : Mağazalar, Ev ve Ofisler
Specifications : Electrostatic anodized aluminum body
Protection Class: IP20
Usage : Stores, Homes, Offices.



Led Tipi Led Type	Renk Isısı Color Temperature	Toplam Güç Total Power	Boyutlar Size	Voltaj Voltage	Duy Socket
GU10 LED	2700/3000K	5.4W	80X80/85/65mm	220V	GU10

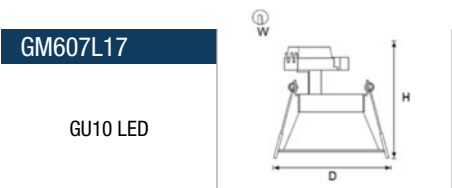

Ürün Özellikleri : Elektrostatik toz boyalı alüminyum gövde
Koruma sınıfı, IP20
Kullanım Alanları : Mağazalar, Ev ve Ofisler
Specifications : Electrostatic anodized aluminum body
Protection Class: IP20
Usage : Stores, Homes, Offices.



GM607L18

GU10 LED

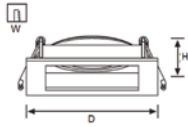

Led Tipi Led Type	Renk Isısı Color Temperature	Toplam Güç Total Power	Boyutlar Size	Voltaj Voltage	Duy Socket
GU10 LED	2700/3000K	1X5W	115X115/75/95X95mm	220V	GU10
GU10 LED	2700/3000K	2X5W	115X230/75/95X210mm	220V	GU10

- Ürün Özellikleri** : Elektrostatik toz boyalı metal gövde
Koruma sınıfı, IP20
Işıl iletkenliği yüksek GU10 LED Ampul
- Kullanım Alanları** : Alışveriş merkezleri, Mağazalar, Ofisler
- Specifications** : Electrostatic anodized metal body
Protection Class, IP20
High Luminosity GU10 LED Bulb
- Usage** : Shopping Malls, Stores, Offices



GM607L19

GU10 LED



Led Tipi Led Type	Renk Isısı Color Temperature	Toplam Güç Total Power	Boyutlar Size	Voltaj Voltage	Duy Socket
GU10 LED	2700/3000K	1X5W	90X90/75/70X70mm	220V	GU10
GU10 LED	2700/3000K	2X5W	90X165/75/70X145mm	220V	GU10

- Ürün Özellikleri** : Elektrostatik toz boyalı metal gövde
Koruma sınıfı, IP20
Işıl iletkenliği yüksek GU10 LED Ampul
- Kullanım Alanları** : Alışveriş merkezleri, Mağazalar, Ofisler
- Specifications** : Electrostatic anodized metal body
Protection Class, IP20
High Luminosity GU10 LED Bulb
- Usage** : Shopping Malls, Stores, Offices



Led Tipi Led Type	Renk Isısı Color Temperature	Toplam Güç Total Power	Boyutlar Size	Voltaj Voltage
SMD LED	3000/4000/6500K	1X2W	70X70/50/55X55mm	220V
SMD LED	3000/4000/6500K	1X2W	90X90/50/70X70mm	220V
SMD LED	3000/4000/6500K	1X6W	110X110/50/90X90mm	220V
SMD LED	3000/4000/6500K	1X2W	85X120/50/65X100mm	220V
SMD LED	3000/4000/6500K	1X6W	120X85/50/100X65mm	220V

Ürün Özellikleri : Elektrostatik toz boyalı metal gövde
Yüksek saflıkta alüminyum açılı Reflektör
Koruma sınıfı, IP20
Yüksek verimliliğe sahip dahili LED sürücü
Işıl iletkenliği yüksek SMD LED Ampul

Kullanım Alanları : Alışveriş merkezleri, Mağazalar, Ofisler

Specifications : Electrostatic anodized metal body
Highly pure aluminium angled reflector
Protection Class, IP20
High Efficiency LED Driver
High Luminosity SMD LED Bulb

Usage : Shopping Malls, Stores, Offices



GM607L20

SMD LED

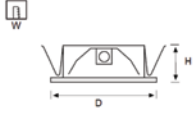

Led Tipi Led Type	Renk Isısı Color Temperature	Toplam Güç Total Power	Boyutlar Size	Voltaj Voltage
SMD LED	3000/4000/6500K	1X2W	30X135/35/20X120mm	220V
SMD LED	3000/4000/6500K	1X5W	60X240/45/45X220mm	220V

Ürün Özellikleri : Elektrostatik toz boyalı paslanmaz gövde
Koruma sınıfı, IP44
Yüksek verimliliğe sahip dahili LED sürücü
Işıl iletkenliği yüksek SMD LED

Kullanım Alanları : Alışveriş merkezleri, Mağazalar, Ofisler

Specifications : Electrostatic anodized stainless body
Protection Class, IP44
High Efficiency LED Driver
High Luminosity SMD LED

Usage : Shopping Malls, Stores, Offices



GM607L21

SMD LED

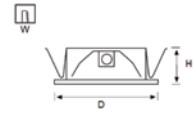

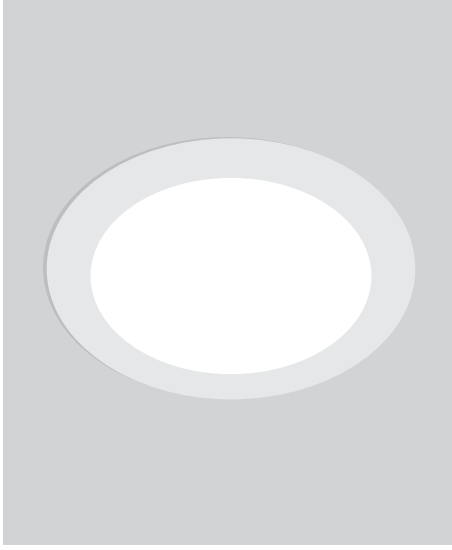

Led Tipi Led Type	Renk Isısı Color Temperature	Toplam Güç Total Power	Boyutlar Size	Voltaj Voltage	Toplam Lümen Total Lumen
SMD LED	3000/4000/6500K	8W	90/25/80mm	220V	720lm
SMD LED	3000/4000/6500K	12W	122/25/105mm	220V	1116lm
SMD LED	3000/4000/6500K	18W	175/25/156mm	220V	1710lm
SMD LED	3000/4000/6500K	23W	225/25/200mm	220V	2230lm

Ürün Özellikleri : Elektrostatik toz boyalı alüminyum gövde
Yüksek geçirgenlikli PMMA opal difüzör
Koruma sınıfı, IP20
Yüksek verimliliğe sahip LED sürücü
Işıl iletkenliği yüksek SMD LED

Kullanım Alanları : Ofis, Eğitim alanları, Hastane, Mağazalar

Specifications : Electrostatic anodized aluminium body
Highly permeable PMMA opal diffuser
Protection Class, IP20
High Efficiency LED Driver
High Luminosity SMD LED

Usage : Offices, Schools, Hospital, Stores

GM607L22

SMD LED

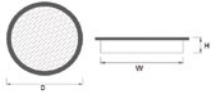



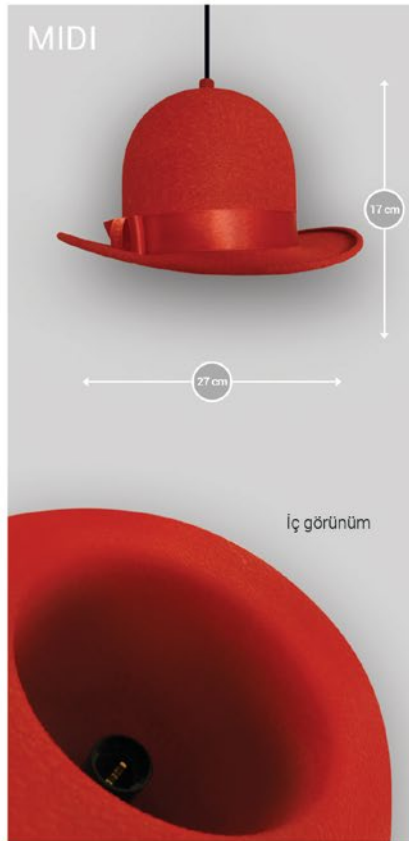
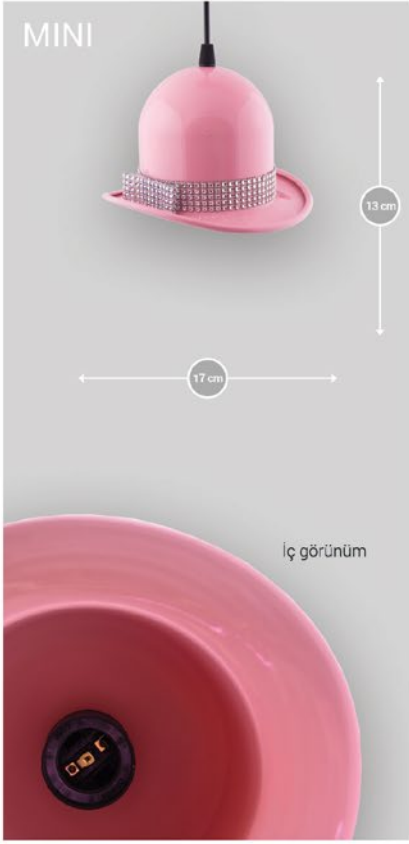



İç görünüm



İç görünüm



İç görünüm



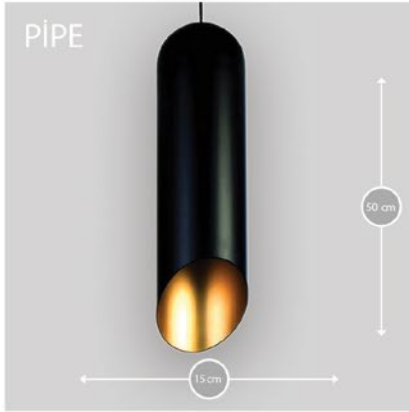

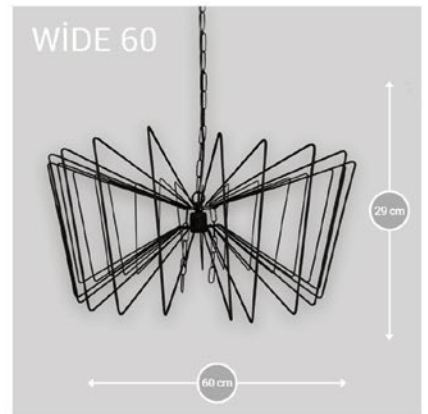

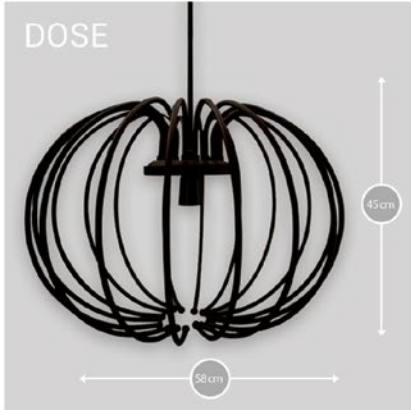

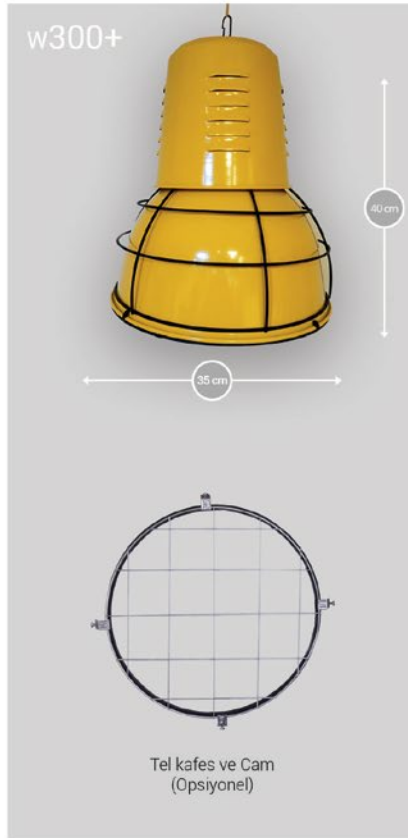
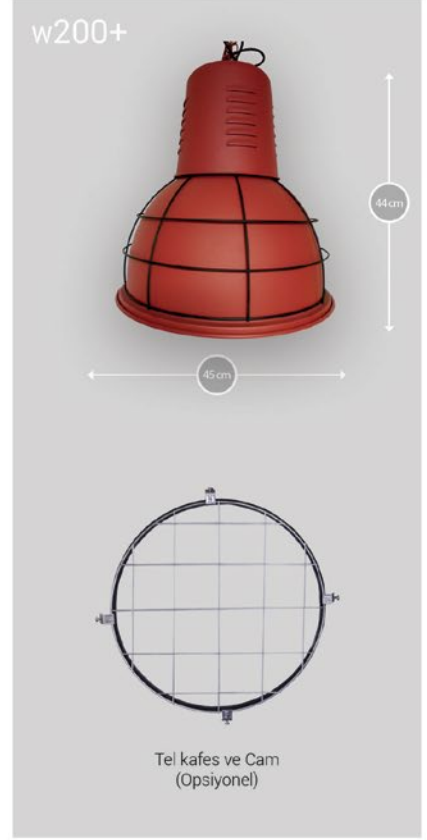
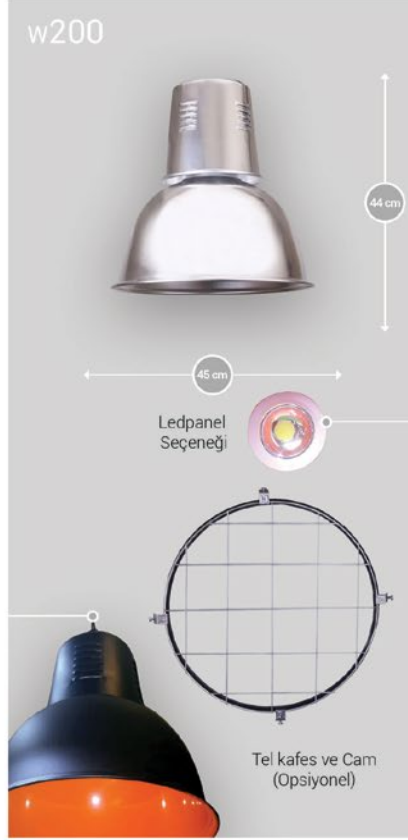





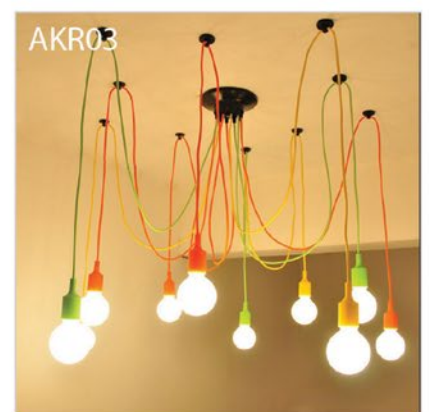







Led Tipi Led Type	Lens Lens	Sürücü Driver	Üst Kapak Top Cover	Voltaj Voltage	Koruma Protection
CREE XPE 350 MA	30° - 60°	Meanwell	PMMA	220V	IP 44

İstenilen ölçülerde üretilebilir

Kullanım Alanları : Standart ledlerin (SMD) ışık gücünün yetmediği kısımlarda kullanılır. Montaj aparatı sayesinde istediğiniz açıda ayarlama imkanı sunar.

Renkler : Cool White, Naturel White, Warm White, Amber

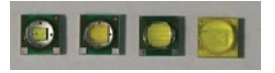
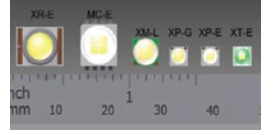

GM202L01
CREE XPE 350 MA



Led Tipi Led Type	Model Model	1W/Lümen 1W/Lumen	Max. Sürme Akımı Max. Driving current	1 Metre/Lumen 1M/Lumen
SAMSUNG	56*30 SMD GEN1	129lm/Watt	150mA	2012lm
SAMSUNG	56*30 SMD GEN2	152lm/Watt	150mA	2371lm

Kullanım Alanları : Her türlü gizli aydınlatma, niş araları, gergi tavan altı yapısı vb. uygulamalarda kullanılabilir.

Renkler : Cool White, Naturel White, Warm White

GM202L02
SAMSUNG

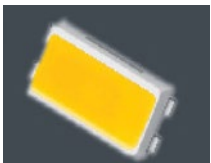



Kullanım alanları : Mobilya, mermer arası basamaklar gibi yüzeye sıfır olması gereken noktalarda kullanılmaktadır

Ürün Özellikleri : PMMA difuze kapak
Polimer yalıtıma uygundur
12V - 24V giriş voltajı

Renkler : Cool White, Naturel White, Warm White, Amber
RGB, Red, Green, Blue

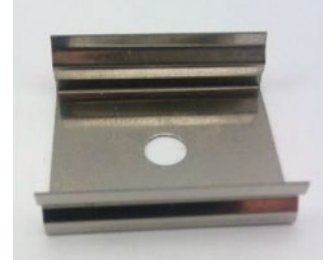

GM202L03

CREE XPE 350 MA



Led Tipi Led Type	Led Adedi Led Aded	Sürücü Driver	Lens Lens	Voltaj Voltage
POWER LED	41cm/12 Led / 57cm/18 led	Meanwell	30° - 45° - 60°	220V

Kullanım Alanları : Dış cephelerin ışıklandırılmasında yere gömülerek kullanılır

Ürün Özellikleri : Alüminyum gövde

Renkler : Cool White, Naturel White, Warm White,
Amber, RGB, Red, Green, Blue

GM202L04

CREE XPE 350 MA





Kullanım alanları : Mobilya, Ev, Ofis Avm, vb. mekanlarda UV baskılı, lake veya transparan olarak uygulanır.

Ürün Özellikleri : Boya ve bakım gerektirmez
Sökülüp tekrar monte edilebilir
Antistatik ve Antiseptik
Akustik
Yalıtkan ve nem tutmaz Renk Değişimi
Alev almaz

Renkler : Cool White, Naturel White, Warm White, Amber
RGB, Red, Green, Blue

GM202L05

CREE XPE 350 MA

